

Product Specification				
	Model: GKTW50SPCH6R0	Rev. No.	Issued Date.	Page.
		B	OCT. 22, 12	1 / 19

Thin-Film-Transistor LCD Module  
 Model: GKTW50SPCH6R0

Acceptance

**Solomon Goldentek Display Corp.**  
**NO. 18 Ta-Yeh St., Ta-Fa Industrial Park, Ta-Liao**  
**Hsiang, Kaohsiung Hsien 831, TAIWAN , R.O.C.**  
 FAX: 886-7-7886800

Approved and Checked by

Approved by	Checked by		Made by
			

### Product Specification

	Model: GKTW50SPCH6R0	Rev. No.	Issued Date.	Page.
		B	OCT. 22, 12	2 / 19

Revise Records

Rev.	Date	Contents	Written	Approved
A	2012/08/20	Preliminary Specification	SK Chen	Kenhung
B	2012/10/23	Modify 1.2 LCD Module (Outline Dimension) & 2. Mechanical Information 120.8*76.0*4.5mm→118.5*77.55*4.5mm Modify 3.3.3 Power Sequence	SK Chen	Roger Yang

Special Notes

Note1.	
Note2.	
Note3.	
Note4.	
Note5.	

Product Specification				
	Model: GKTW50SPCH6R0	Rev. No.	Issued Date.	Page.
		B	OCT. 22, 12	3 / 19

## Contents

<b>1. General Description and Features</b> .....	4
1.1 Features .....	4
1.2 LCD Module .....	4
<b>2. Mechanical Information</b> .....	4
<b>3. Electrical Specifications</b> .....	5
3.1 Absolute Max. Ratings .....	5
3.2 Electrical Characteristics .....	5
3.3 AC Timing Characteristic of The LCD .....	6
3.4 Back-Light Unit.....	9
<b>4. Optical Characteristics</b> .....	10
4.1 Optical characteristic of the LCD.....	10
<b>5. Touch Screen Panel Specifications</b> .....	13
5.1 Touch Screen Panel Specifications.....	13
<b>6. I/O Terminal</b> .....	14
6.1 Pin Assignment .....	14
6.2 Block Diagram .....	16
6.3 Basic Display Color and Gray Scale .....	17
<b>7. Test</b> .....	18
<b>8. Dimensional Outlines</b> .....	19

## Product Specification

 <b>SGD</b> <sup>®</sup> DISPLAY THE WORLD	Model:      GKTW50SPCH6R0	Rev. No.	Issued Date.	Page.
		B	OCT. 22, 12	4 / 19

### 1. General Description and Features

GKTW50SPCH6R0 is a transmissive type color active matrix TFT (Thin Film Transistor) liquid crystal display (LCD) that uses amorphous silicon TFT as a switching device. This model is composed of a TFT-LCD module, a driver circuit and a back-light unit and touch screen panel(TSP). Graphics and texts can be displayed on a WVGA 800 (H) x 3 x 480 (V) dots with 16.7M colors by supplying 24 bits data signal (8bits/each color). The following table described the features of GKTW50SPCH6R0.

#### 1.1 Features

- Transmissive and back-light with 14 LEDs are available.
- TN (Twisted Nematic) mode.
- Digital RGB (24bits/color) data transfer.
- Data enable mode.
- 4-wire Touch panel
- ROHS Compliance.

#### 1.2 LCD Module

Item	Specification	Unit
Screen Size	5.0 inches	Diagonal
Display Resolution	800 (H) x 480 (V)	Pixel
Active Area	108.0 (H) x 64.8 (V)	mm
Outline Dimension	118.5(H) x 77.55 (V) x 4.5 (T)	mm
Display Mode	Normally white mode/ Transmissive/ Wide view	--
Pixel Arrangement	R,G,B Vertical Tripe	--
Pixel size	135 x 135	um
Surface Treatment	Anti-glare (AG)	--
Display Color	16.7M	--
Viewing Direction	6 o'clock	--
Input Interface	Digital RGB (8 bits/color) Data Transfer	--

### 2. Mechanical Information

Item	Min.	Typ.	Max.	Unit	Note	
Module Size	Horizontal (H)	118.2	118.5	118.8	mm	(1,2,3)
	Vertical (V)	77.25	77.55	77.85	mm	(2)
	Thickness (T)	4.3	4.5	4.7	mm	(1,3)
Weight	--	--	--	--	--	

Note (1) Not include FPC. Refer to the Outline Dimension Drawing as attached.

(2) Back-light unit is included.

(3) Excluding backlight cables.

## Product Specification

	Model:      GKTW50SPCH6R0	Rev. No.	Issued Date.	Page.
		B	OCT. 22, 12	5 / 19

### 3. Electrical Specifications

#### 3.1 Absolute Max. Ratings

##### 3.1.1 Absolute Ratings of Environment

If the operating condition exceeds the following absolute maximum ratings, the TFT LCD module may be damaged permanently.

(Ta=25±2°C, V<sub>SS</sub>=GND=0)

Item	Symbol	Min.	Max.	Unit	Note
Storage temperature	T <sub>STG</sub>	-30	80	°C	(1)
Operating temperature	T <sub>OPR</sub>	-20	70	°C	(1,2,3)

Note (1) 95 % RH Max. ( 40 °C ≥ Ta ). Maximum wet-bulb temperature at 39 °C or less. (Ta > 40 °C) No condensation.

Note (2) In case of below 0°, the response time of liquid crystal (LC) becomes slower and the color of panel becomes darker than normal one. Level of retardation depends on temperature, because of LC's character

Note (3) Only operation is guaranteed at operating temperature. Contrast, response time, another display quality are evaluated at +25°C.

##### 3.1.2 Electrical Absolute Maximum Ratings

(V<sub>SS</sub>=GND=0)

Parameter	Symbol	Min.	Max.	Unit	Remark
Power supply voltage	V <sub>DD</sub>	-0.5	5.0	V	--
Signal input voltage	V <sub>i</sub>	-0.3	VDD+0.3	V	--

Note: (1) Permanent damage may occur to the LCD module if beyond this specification. Functional operation should be restricted to the conditions described under normal operating conditions.

(2) Ta =25±2°C

#### 3.2 Electrical Characteristics

##### 3.2.1 DC Electrical Characteristics of the TFT LCD

(Ta=25±2°C, V<sub>SS</sub>=GND=0)

Item	Symbol	Min.	Typ.	Max.	Unit	Remark	
Power supply	V <sub>DD</sub>	3.0	3.3	3.6	V		
Input Voltage for logic	H Level	V <sub>iH</sub>	0.7VDD	-	VDD	V	Note 1
	L Level	V <sub>iL</sub>	GND	-	0.3VDD	V	Note 1
Power Supply current	I <sub>DD</sub>	-	-	(220)	mA	V <sub>DD</sub> =3.3V	

Note1: HSYNC , VSYNC ,DE ,R/G/B Data

## Product Specification

	Model:      GKTW50SPCH6R0	Rev. No.	Issued Date.	Page.
		B	OCT. 22, 12	6 / 19

### 3.3 AC Timing Characteristic of The LCD

#### 3.3.1 Timing Condition

Parameter	Symbol	Min.	Typ.	Max.	Unit.	Remark
DCLK cycle time	Tclk	25			ns	
DCLK frequency	fclk		33	40	MHZ	
DCLK pulse duty	Tcwh	40	50	60	%	
VSYNC setup time	Tvst	8			ns	
VSYNC hold time	Tvhd	8			ns	
HSYNC setup time	Thst	8			ns	
HSYNC hold time	Thhd	8			ns	
Data setup time	Tdasu	8			ns	
Data hold time	Tdahd	8			ns	
DE setup time	Tdesu	8			ns	
DE hold time	Tdehd	8			ns	
Horizontal display area	Thd		800		Tcph	
HSYNC Period time	Th		928		Tcph	
HSYNC width	Thwh	1	48		Tcph	
HSYNC back porch	Thbp		40		Tcph	
HSYNC front porch	Thfp		40		th	
Vertical display area	Tvd		480		th	
VSYNC period time	Tv		525		th	
VSYNC width	Tvwh		3		th	
VSYNC back porch	Tvbp		29		th	
VSYNC front porch	Tvfp		13		th	

## Product Specification

	Model: GKTW50SPCH6R0	Rev. No.	Issued Date.	Page.
		B	OCT. 22, 12	7 / 19

### 3.3.2 Timing Diagram of Interface Signal

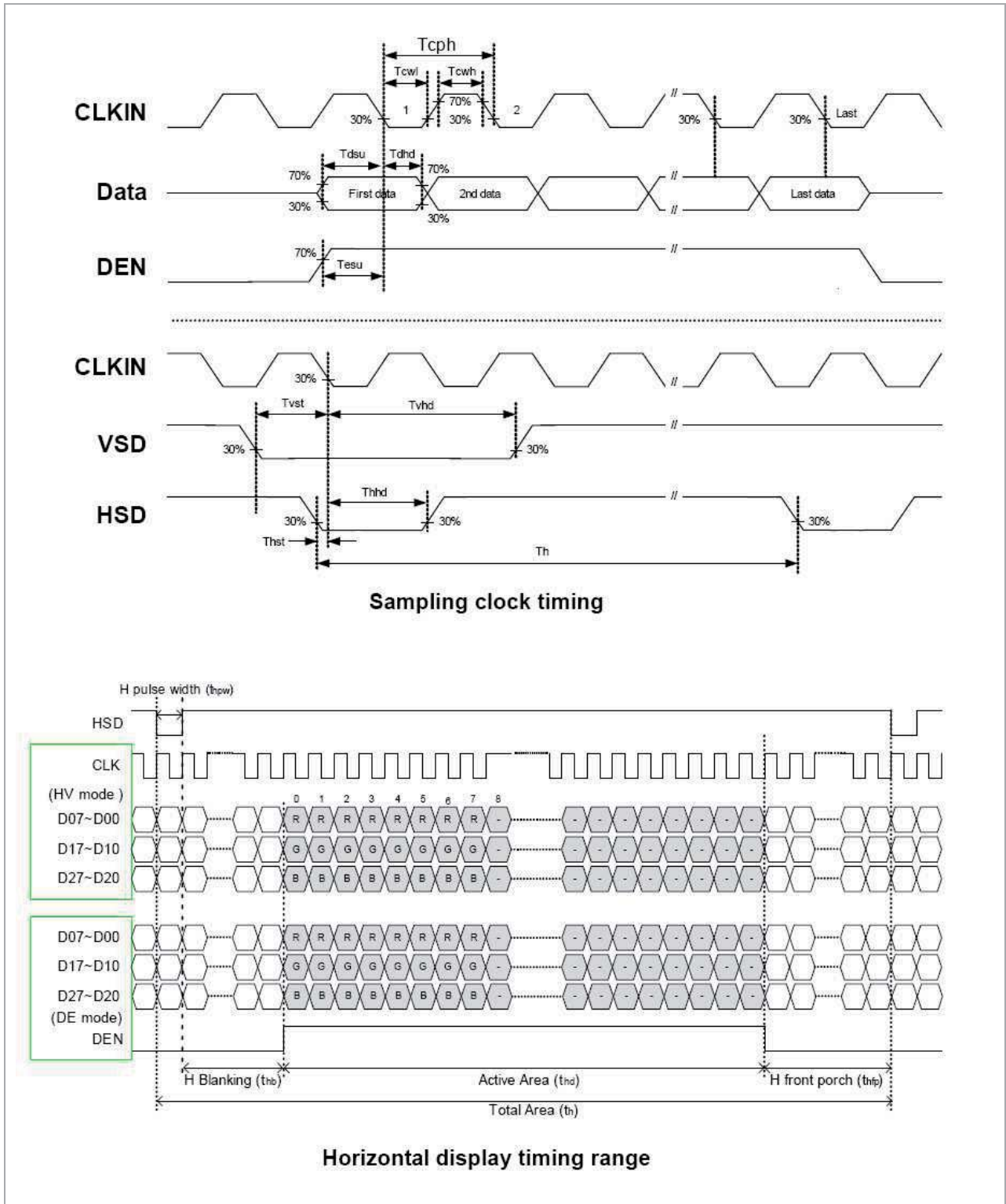

**Product Specification**

	Model: GKTW50SPCH6R0	Rev. No.	Issued Date.	Page.
		B	OCT. 22, 12	8 / 19

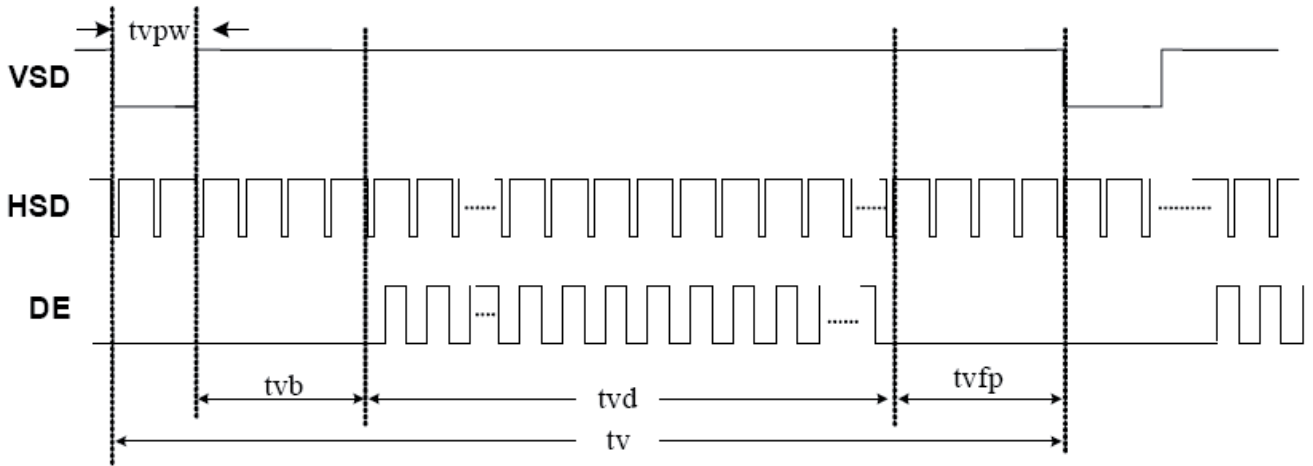

**Vertical timing**

3.3.3 Power Sequence

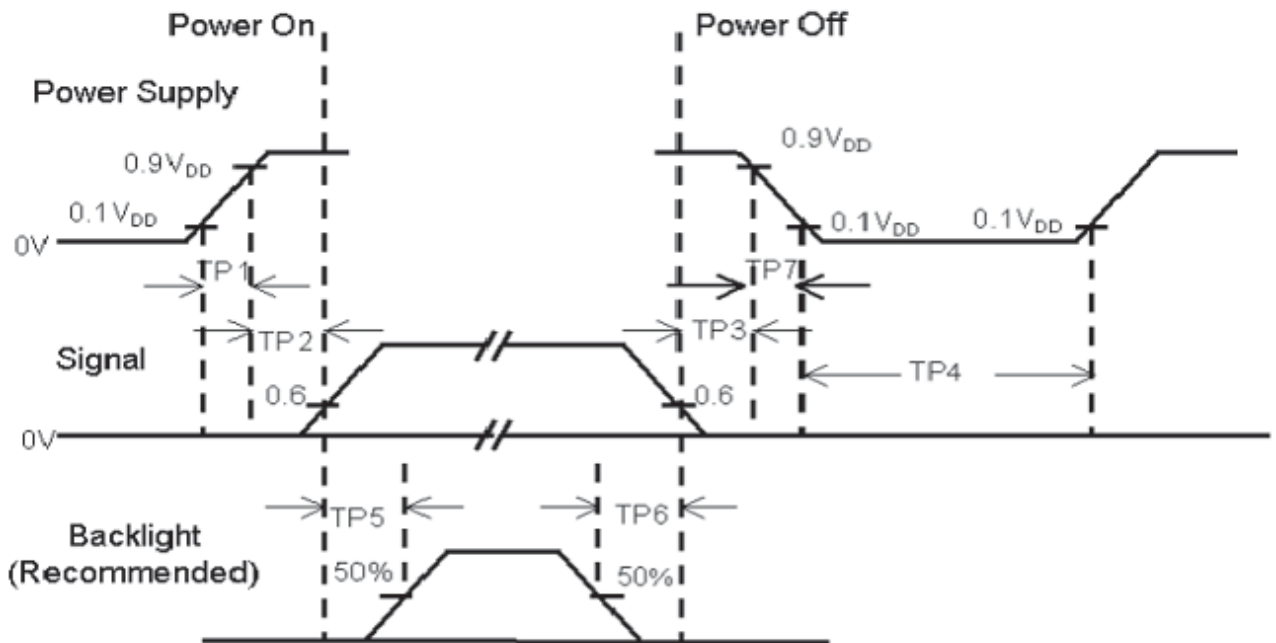



## Product Specification

	Model:      GKTW50SPCH6R0	Rev. No.	Issued Date.	Page.
		B	OCT. 22, 12	9 / 19

Item	Min.	TYP.	Max.	Unit
T1	0.5	-	10	msec
T2	0	-	50	msec
T3	0	-	50	msec
T4	1000	-	-	msec
T5	200	-	-	msec
T6	200	-	-	msec
T7	0.5	-	10	msec

- Note :
- (1) The supply voltage of the external system for the module input should be the same as the definition of VDD.
  - (2) Apply the lamp voltage within the LCD operation range. When the back-light turns on before the LCD operation or the LCD turns off before the back-light turns off, the display may momentarily become white.
  - (3) In case of VDD = off level, please keep the level of input signal on the low or keep a high impedance.
  - (4) TP4 should be measured after the module has been fully discharged between power off and on period.
  - (5) Interface signal shall not be kept at high impedance when the power is on.

### 3.4 Back-Light Unit

The Back-light system is an edge-lighting type with 12white LEDs (Light Emitting Diode). The characteristics of 12 white LEDs are shown in the following tables.

(Ta= Room Temp)

Characteristics	Symbol	Min.	Typ.	Max.	Unit	Note
Current	$I_L$	-	40	(50)	mA	(1)
Voltage	$V_L$	(21)	(23.1)	(23.8)	V	
Power Consumption	$P_{BL}$	-	(924)	(1190)		
LED Life time	-	(20000)	-	-	hr	(3)

Note (1) LEDs in 7 series x 2 parallel type.

(2) Where  $I_L = 40\text{mA}$ ,  $V_L = 23.1$

(3) The environmental conducted under ambient air flow ,at  $T_a = 25 \pm 2^\circ\text{C}$ ,  $60\%RH \pm 5\%$

## Product Specification

	Model:      GKTW50SPCH6R0	Rev. No.	Issued Date.	Page.
		B	OCT. 22, 12	10 / 19

### 4. Optical Characteristics

#### 4.1 Optical characteristic of the LCD

The following items are measured under stable conditions. The optical characteristics should be measured in a dark room or equivalent state.

Measuring equipment: BM-5A, BM-7

Item	Symbol	Condition	Min	Type	Max	Unit	Note
Brightness	B		(500)	(600)	--	cd/m <sup>2</sup>	
Response time	T <sub>r</sub>	θ=0°	--	(2.4)	--	ms	.
	T <sub>f</sub>		--	(1.4)	--	ms	
Contrast ratio	CR	At optimized viewing angle	(480)	(600)	--	cd/m <sup>2</sup>	
Brightness uniformity		--	70	80	--	%	
	White	W <sub>x</sub>	θ=0° Normal Viewing Angle	(0.26)	(0.31)	(0.36)	--
		W <sub>y</sub>		(0.28)	(0.33)	(0.38)	
Viewing Angle (6H)	Hor.	θ <sub>R</sub>	CR≥10	65	75	--	Degree
		θ <sub>L</sub>		65	75	--	
	Ver.	φ <sub>H</sub>		50	60	--	
		φ <sub>L</sub>		60	70	--	

## Product Specification

	Model: GKTW50SPCH6R0	Rev. No.	Issued Date.	Page.
		B	OCT. 22, 12	11 / 19

a. Test equipment setup

After stabilizing and leaving the panel alone shall be warmed up for the stable operation of LCM, the measurement should be executed. Measurement should be executed in a stable, windless, and dark room. Optical specifications are measured by Topcon BM-7A(fast) with a viewing angle of 2° at a distance of 50cm and normal direction.

b. Definition of response time: Tr and Tf

The response time is defined as the following figure and shall be measured by switching the input signal for "black" and "white".

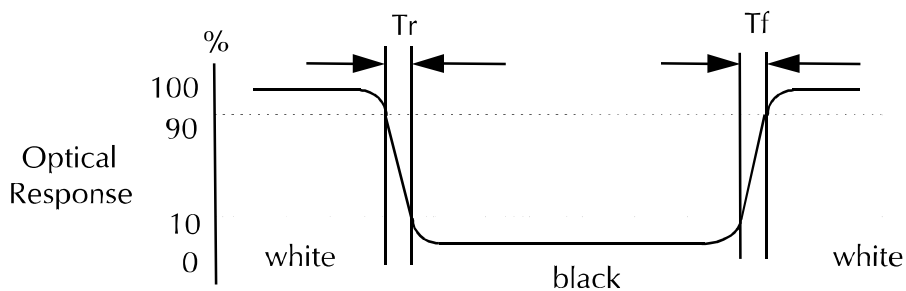

c. Definition of contrast ratio:

$$\text{Contrast Ratio (CR)} = \frac{\text{Brightness measured when LCD is at "white state"}}{\text{Brightness measured when LCD is at "black state"}}$$

d. Measured at the center area of the panel when all the input terminals of LCD panel are electrically opened.

## Product Specification

	Model:     GKTW50SPCH6R0	Rev. No.	Issued Date.	Page.
		B	OCT. 22, 12	12 / 19

e. View Angle

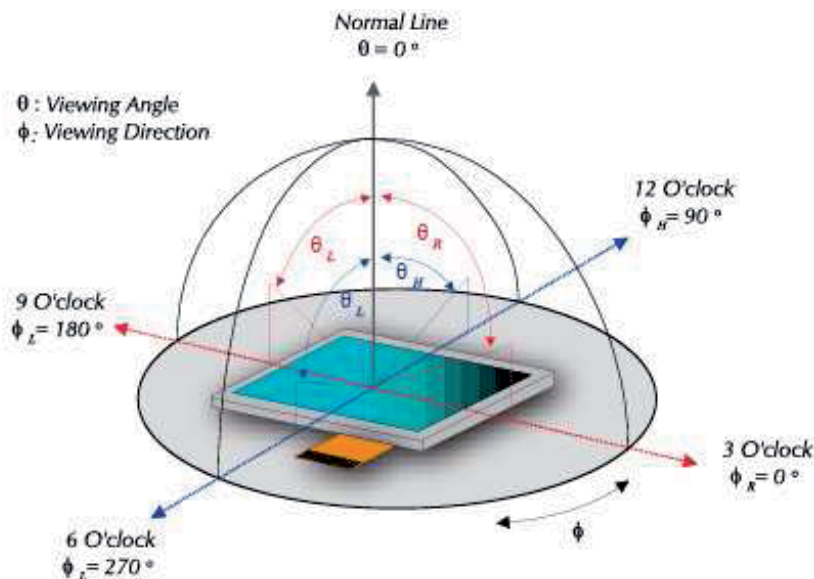

f. Definition of Luminance of White: Luminance of white at the center points

Light Source of Back-Light Unit	LED Type
---------------------------------	----------

g. Definition of White Uniformity

$$\text{White Uniformity} = \frac{\text{Min. luminance of white among 9-points}}{\text{Max. luminance of white among 9-points}}$$

h. The definition of Color Gamut -Color Chromaticity CIE 1931

Color coordinate of white & red, green, blue at center point.

Color Gamut : NTSC(%) = ( RGB Triangle Area / NTSC Triangle Area ) x 100

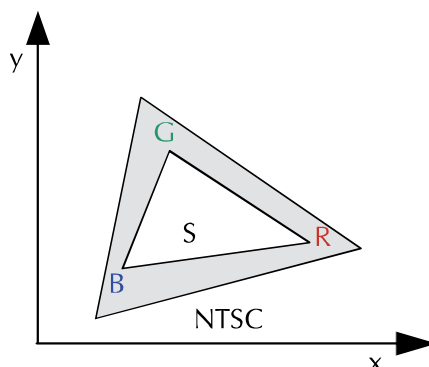

Product Specification				
	Model: GKTW50SPCH6R0	Rev. No.	Issued Date.	Page.
		B	OCT. 22, 12	13 / 19

## 5. Touch Screen Panel Specifications

### 5.1 Touch Screen Panel Specifications

#### 5.1.1 Electrical Characteristics

Item	Min.	Typ.	Max.	Unit	Note
Linearity	-	-	1.5	%	Analog X and Y directions
Terminal resistance	(200)	-	(1000)	$\Omega$	X (Glass side)
	(200)	-	(900)	$\Omega$	Y (Film side)
Insulation resistance	20	-	-	M $\Omega$	DC 25V
Voltage	-	5.0	7.0	V	DC
Chattering	-	-	10	ms	100k $\Omega$ pull-up
Transparency	78	-	-	%	Non-glare

Caution (1): Do not operate it with a thing except a polyacetal pen (tip R0.8mm or less) or a finger, especially those with hard or sharp tips such as a ball point pen or a mechanical pencil.

#### 5.1.2 Mechanical & Reliability Characteristics

Item	Min.	Typ.	Max.	Unit	Note
Activation force	(60)	-	(100)	g	(1)
Durability-surface scratching	Write 100,000	-	-	characters	(2)
Durability-surface pitting	1,000,000	-	-	touches	(3)
Surface hardness	3	-	-	H	JIS K5400,ASTM D3363

Note (1) Stylus pen Input : R0.8mm polyacetal pen or Finger

Note (2) Measurement for Surface area - Scratch 100,000 times straight line on the Film.

- Force : 250gf
- Speed : 60mm/sec(same position (from10mm to 100mm))
- Stylus :  $\Phi$ 2.0 polyacetal pen

Note (2) Pit 1,000,000 times on the Film with a  $\Phi$ 2.6 silicon rubber.

- Force : Force : 250gf
- Speed : 2times/sec

**Product Specification**

	Model: GKTW50SPCH6R0	Rev. No.	Issued Date.	Page.
		B	OCT. 22, 12	14 / 19

**6. I/O Terminal**

## 6.1 Pin Assignment

Pin No.	Symbol	I/O	Function	Remark
1	VLED-	P	Power for LED backlight cathode	
2	VLED+	P	Power for LED backlight anode	
3	GND	P	Power ground	
4	VDD	P	Power voltage	
5	R0	I	Red data(LSB)	
6	R1	I	Red data	
7	R2	I	Red data	
8	R3	I	Red data	
9	R4	I	Red data	
10	R5	I	Red data	
11	R6	I	Red data	
12	R7	I	Red data(MSB)	
13	G0	I	Green data(LSB)	
14	G1	I	Green data	
15	G2	I	Green data	
16	G3	I	Green data	
17	G4	I	Green data	
18	G5	I	Green data	
19	G6	I	Green data	
20	G7	I	Green data(MSB)	
21	B0	I	Blue data(LSB)	
22	B1	I	Blue data	
23	B2	I	Blue data	
24	B3	I	Blue data	
25	B4	I	Blue data	
26	B5	I	Blue data	
27	B6	I	Blue data	
28	B7	I	Blue data(MSB)	
29	DGND	I	Digital ground	
30	DCLK	I	Pixel clock	
31	DISP	I	Display on/off	
32	HSYNC	I	Horizontal sync signal	
33	VSYNC	I	Vertical sync signal	
34	DE	I	Data enable	

**Product Specification**

	Model:      GKTW50SPCH6R0	Rev. No.	Issued Date.	Page.
		B	OCT. 22, 12	15 / 19

35	NC	-	Not Connection	
36	GND	P	Power ground	
37	XR	I	TP Right electrode – differential analog	
38	YD	I	TP Bottom electrode – differential analog	
39	XL	I	TP Left electrode – differential analog	
40	YU	I	TP Top electrode – differential analog	

I/O: I: input, O: Output, P: power

Notes:

- 1) NC Pin must be retained; this pin can't contact GND or other signal.
- 2) GND Pin must ground contact, can not be floating.
- 3) Connector Part No: FH19SC-40S-0.5SH (51) or equivalent.

## Product Specification

	Model: GKTW50SPCH6R0	Rev. No.	Issued Date.	Page.
		B	OCT. 22, 12	16 / 19

### 6.2 Block Diagram

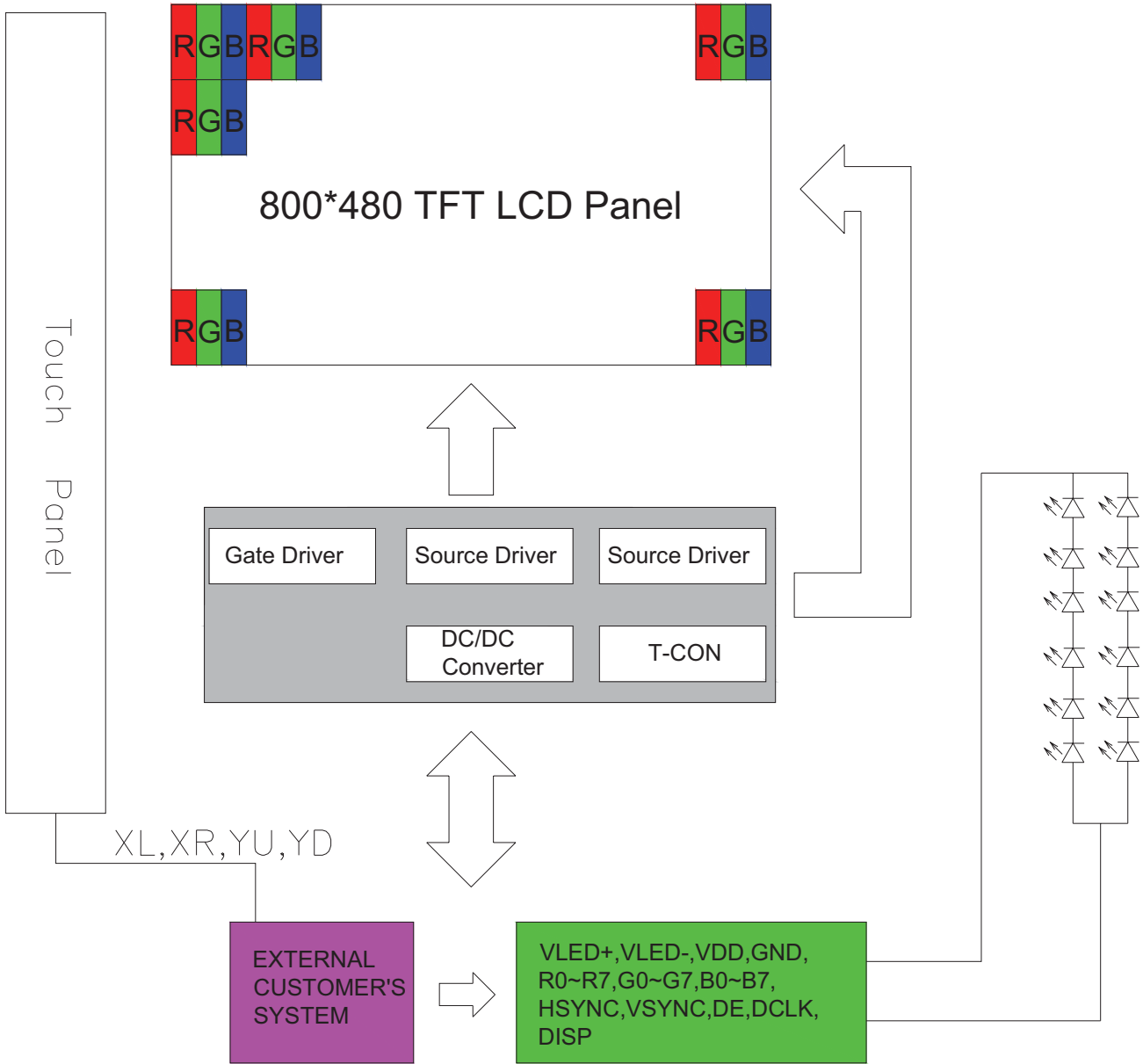



## Product Specification

	Model: GKTW50SPCH6R0	Rev. No.	Issued Date.	Page.
		B	OCT. 22, 12	17 / 19

### 6.3 Basic Display Color and Gray Scale

	Color & Gray Scale	Data Signal																							
		R7	R6	R5	R4	R3	R2	R1	R0	G7	G6	G5	G4	G3	G2	G1	G0	B7	B6	B5	B4	B3	B2	B1	B0
Basic Color	Black	0	0	0	0	0	0	0	0	0	0	0	0	0	0	0	0	0	0	0	0	0	0	0	0
	Red(0)	1	1	1	1	1	1	1	1	0	0	0	0	0	0	0	0	0	0	0	0	0	0	0	0
	Green(0)	0	0	0	0	0	0	0	0	1	1	1	1	1	1	1	1	0	0	0	0	0	0	0	0
	Blue(0)	0	0	0	0	0	0	0	0	0	0	0	0	0	0	0	0	1	1	1	1	1	1	1	1
	Cyan	0	0	0	0	0	0	0	0	1	1	1	1	1	1	1	1	1	1	1	1	1	1	1	1
	Magenta	1	1	1	1	1	1	1	1	0	0	0	0	0	0	0	0	1	1	1	1	1	1	1	1
	Yellow	1	1	1	1	1	1	1	1	1	1	1	1	1	1	1	1	0	0	0	0	0	0	0	0
	White	1	1	1	1	1	1	1	1	1	1	1	1	1	1	1	1	1	1	1	1	1	1	1	1
Red	Black	0	0	0	0	0	0	0	0	0	0	0	0	0	0	0	0	0	0	0	0	0	0	0	
	Red(1)	0	0	0	0	0	0	0	1	0	0	0	0	0	0	0	0	0	0	0	0	0	0	0	
	Red(2)	0	0	0	0	0	0	1	0	0	0	0	0	0	0	0	0	0	0	0	0	0	0	0	
	:	:	:	:	:	:	:	:	:	:	:	:	:	:	:	:	:	:	:	:	:	:	:	:	
	Red(31)	0	1	1	1	1	1	1	1	0	0	0	0	0	0	0	0	0	0	0	0	0	0	0	
	:	:	:	:	:	:	:	:	:	:	:	:	:	:	:	:	:	:	:	:	:	:	:	:	
	Red(62)	1	1	1	1	1	1	1	0	0	0	0	0	0	0	0	0	0	0	0	0	0	0	0	
	Red(63)	1	1	1	1	1	1	1	1	0	0	0	0	0	0	0	0	0	0	0	0	0	0	0	
Green	Black	0	0	0	0	0	0	0	0	0	0	0	0	0	0	0	0	0	0	0	0	0	0	0	
	Green(1)	0	0	0	0	0	0	0	0	0	0	0	0	0	0	0	1	0	0	0	0	0	0	0	
	Green(2)	0	0	0	0	0	0	0	0	0	0	0	0	0	0	1	0	0	0	0	0	0	0	0	
	:	:	:	:	:	:	:	:	:	:	:	:	:	:	:	:	:	:	:	:	:	:	:	:	
	Green(31)	0	0	0	0	0	0	0	0	0	1	1	1	1	1	1	1	0	0	0	0	0	0	0	
	:	:	:	:	:	:	:	:	:	:	:	:	:	:	:	:	:	:	:	:	:	:	:	:	
	Green(62)	0	0	0	0	0	0	0	0	1	1	1	1	1	1	1	0	0	0	0	0	0	0	0	
	Green(63)	0	0	0	0	0	0	0	0	1	1	1	1	1	1	1	1	0	0	0	0	0	0	0	
Blue	Black	0	0	0	0	0	0	0	0	0	0	0	0	0	0	0	0	0	0	0	0	0	0	0	
	Blue(1)	0	0	0	0	0	0	0	0	0	0	0	0	0	0	0	0	0	0	0	0	0	0	1	
	Blue(2)	0	0	0	0	0	0	0	0	0	0	0	0	0	0	0	0	0	0	0	0	0	0	1	
	:	:	:	:	:	:	:	:	:	:	:	:	:	:	:	:	:	:	:	:	:	:	:	:	
	Blue(31)	0	0	0	0	0	0	0	0	0	0	0	0	0	0	0	0	1	1	1	1	1	1	1	
	:	:	:	:	:	:	:	:	:	:	:	:	:	:	:	:	:	:	:	:	:	:	:	:	
	Blue(62)	0	0	0	0	0	0	0	0	0	0	0	0	0	0	0	0	1	1	1	1	1	1	0	
	Blue(63)	0	0	0	0	0	0	0	0	0	0	0	0	0	0	0	0	1	1	1	1	1	1	1	

0 : Low level voltage, 1 :High level voltage

Each basic color can be displayed in 256 gray scales from 8 bit data signals. With the combination of total 24 bit data signals, the 16.7M color display can be achieved on the screen.

## Product Specification

	Model:      GKTW50SPCH6R0	Rev. No.	Issued Date.	Page.
		B	OCT. 22, 12	18 / 19

### 7. Test

No change on display and in operation under the following test condition.

Condition: Unless otherwise specified, tests will be conducted under the following condition.

Temperature: 20±5°C.

Humidity: 65±5%RH.

Tests will be not conducted under functioning state.

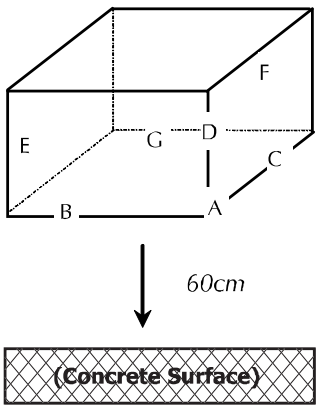
No.	Parameter	Condition	Notes
1	High Temperature Operating	70°C±2°C, 240hrs (Operation state).	
2	Low Temperature Operating	-20°C±2°C, 240hrs (Operation state).	1
3	High Temperature Storage	80°C±2°C, 240hrs.	2
4	Low Temperature Storage	-30°C±2°C, 240hrs.	1,2
5	High Temperature and High Humidity Operation Test	60°C±2°C, 90%, 240hrs.	1,2
6	Vibration Test	Total fixed amplitude: 1.5mm. Vibration Frequency: 10~55Hz. One cycle 60 seconds to 3 direction of X, Y, Z each 15 minutes.	3
7.	Drop Test	<p>To be measured after dropping from 60cm high on the concrete surface in packing state.</p> <div style="text-align: center;">  </div> <p style="text-align: right; color: blue;"><i>Dropping method corner dropping:</i></p> <p style="text-align: right; color: blue;"><i>A corner: Once edge dropping.</i></p> <p style="text-align: right; color: blue;"><i>B, C, D edge: Once face dropping.</i></p> <p style="text-align: right; color: blue;"><i>E, F, G face: Once.</i></p>	

- Notes:
1. No dew condensation to be observed.
  2. The function test shall be conducted after 4 hours storage at the normal temperature and humidity after removed from the test chamber.
  3. Vibration test will be conducted to the product itself without putting I in a container.

# Product Specification

Model: GKTW50SPCH6R0	Rev. No.	Issued Date.	Page.
	B	OCT. 22, 12	19 / 19

## 8. Dimensional Outlines

