



STEP-UP, SUPER-SMALL PACKAGE, 1.2 MHz PWM CONTROL or PWM/PFM SWITCHABLE SWITCHING REGULATOR CONTROLLER

www.sii-ic.com

© Seiko Instruments Inc., 2009-2010

Rev.2.0_00

The S-8365/8366 Series is a CMOS step-up switching regulator controller which mainly consists of a reference voltage source, an oscillation circuit, an error amplifier, a phase compensation circuit, a timer latch short-circuit protection circuit, a PWM control circuit (S-8365 Series) and a PWM / PFM switching control circuit (S-8366 Series).

With an external low-ON-resistance Nch Power MOS, this product is ideal for applications requiring high efficiency and a high output current.

The S-8365 Series efficiently works on voltage's condition of large I/O difference due to the PWM control circuit linearly varies the duty ratio to 90%.

During light-load, the S-8366 Series switches its operation to the PFM control by the PWM / PFM switching control circuit in order to prevent efficiency decline due to the IC operating current.

Ceramic capacitors can be used for output capacitor. Small packages SNT-6A, SOT-23-5 and SOT-23-6 enable high-density mounting.

■ Features

- Low operation voltage : Start at 1.1 V (1 mA) guaranteed (in the product without UVLO function)
- Input voltage range : 1.8 V to 5.5 V
- Oscillation frequency : 1.2 MHz, 600 kHz
- Reference voltage : 0.6 V \pm 2.0%
- Soft start function : 7 ms typ.
- Low current consumption : 70 μ A typ. at switching off
- Duty ratio : Built-in PWM / PFM switching control circuit (S-8366 Series)
28% to 85% (1.2 MHz product)
28% to 90% (600 kHz product)

- Shutdown function : Current consumption 1.0 μ A max. at shutdown
- External parts : Inductor, diode, capacitor, transistor
- Timer latch short-circuit protection circuit : Selectable with / without short-circuit protection circuit for each product
Settable delay time by external capacitor
(in the product with short-circuit protection)

- UVLO (under-voltage lockout) function : Selectable with / without UVLO for each product
- Lead-free, Sn 100%, halogen-free^{*1}

*1. Refer to "■ Product Name Structure" for details.

■ Applications

- MP3 players, digital audio players
- Digital cameras, GPS, wireless transceiver
- Portable devices

■ Packages

- SNT-6A
- SOT-23-5
- SOT-23-6

■ **Block Diagram**

1. With UVLO function and short-circuit protection

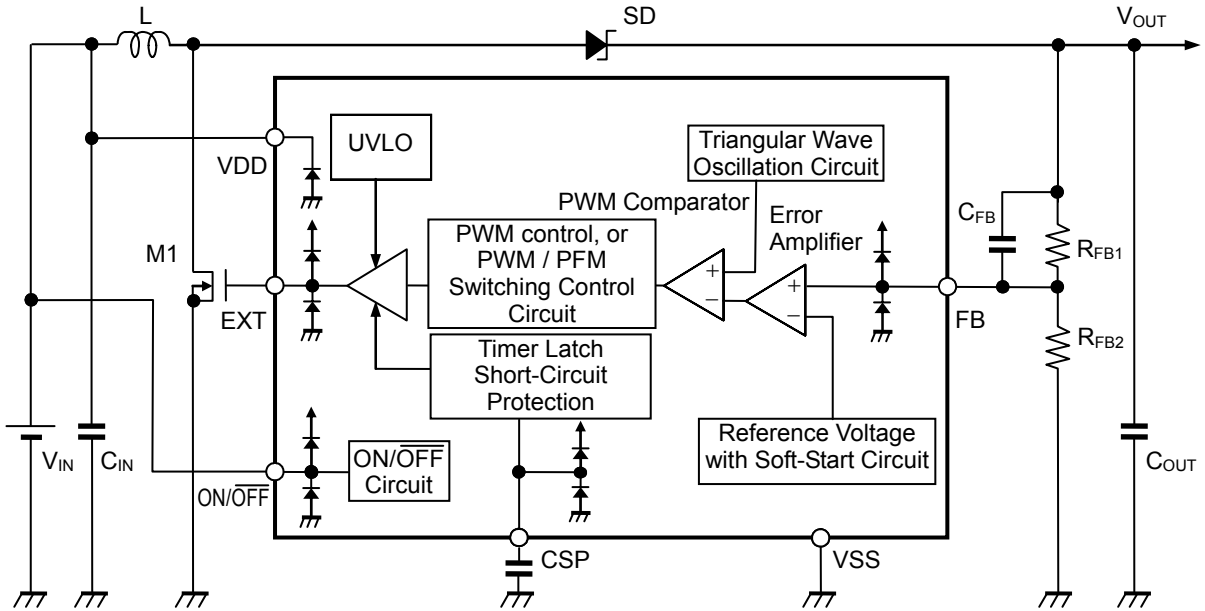

Figure 1

2. With UVLO function, without short-circuit protection

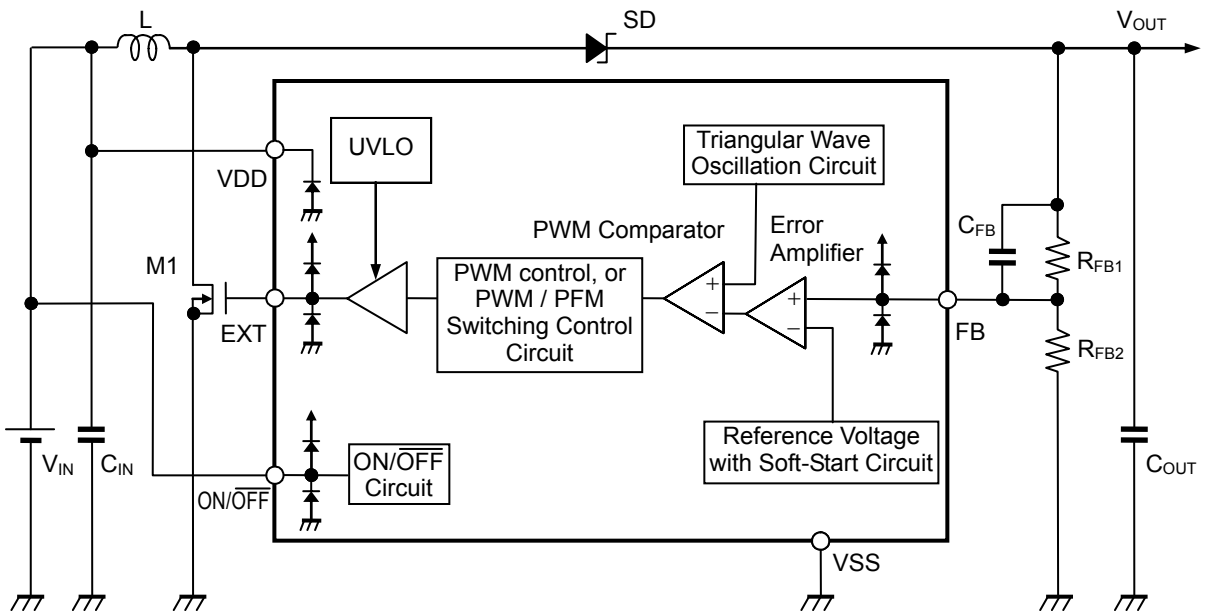

Figure 2

3. Without UVLO and short-circuit protection

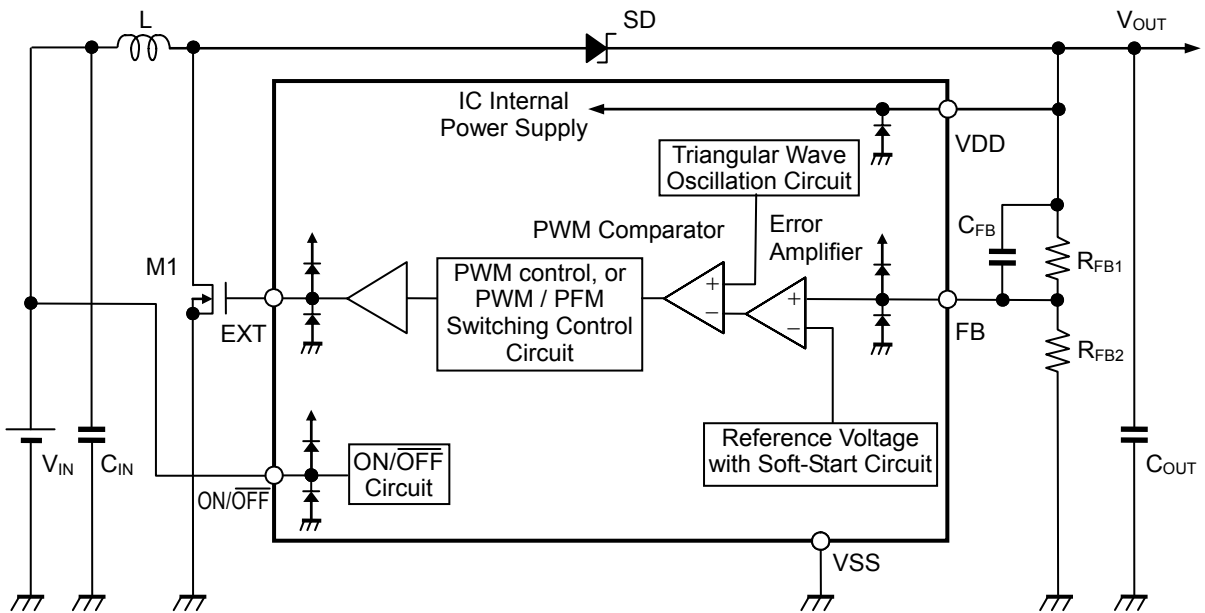

Figure 3

Caution To stabilize the output voltage and oscillation frequency of the S-8365/8366 Series, the input voltage of $1.8\text{ V} \leq V_{DD} \leq 5.5\text{ V}$ is necessary. When connecting the V_{OUT} output to the V_{DD} pin, set the input voltage (V_{OUT}) as to satisfy the above range, including the spike voltage generated in V_{OUT} .

■ Product Name Structure

Users can select the control system, oscillation frequency, short-circuit protection, UVLO function, packages for the S-8365/8366 Series. Refer to “**1. Product name**” regarding the contents of product name, “**2. Package**” regarding the package drawings and “**3. Product list**” regarding the product type.

1. Product name

(1) SNT-6A

S-836 x A x x x x - I6T1 x 2

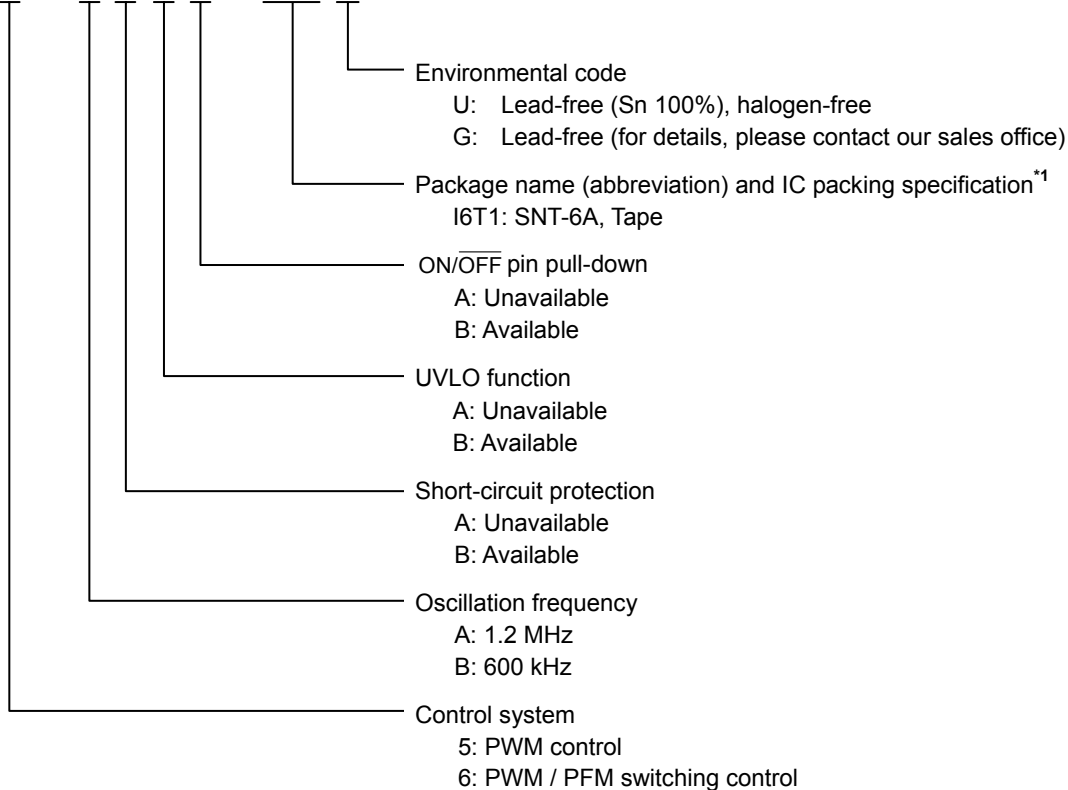

*1. Refer to the tape specification.

(2) SOT-23-5, SOT-23-6

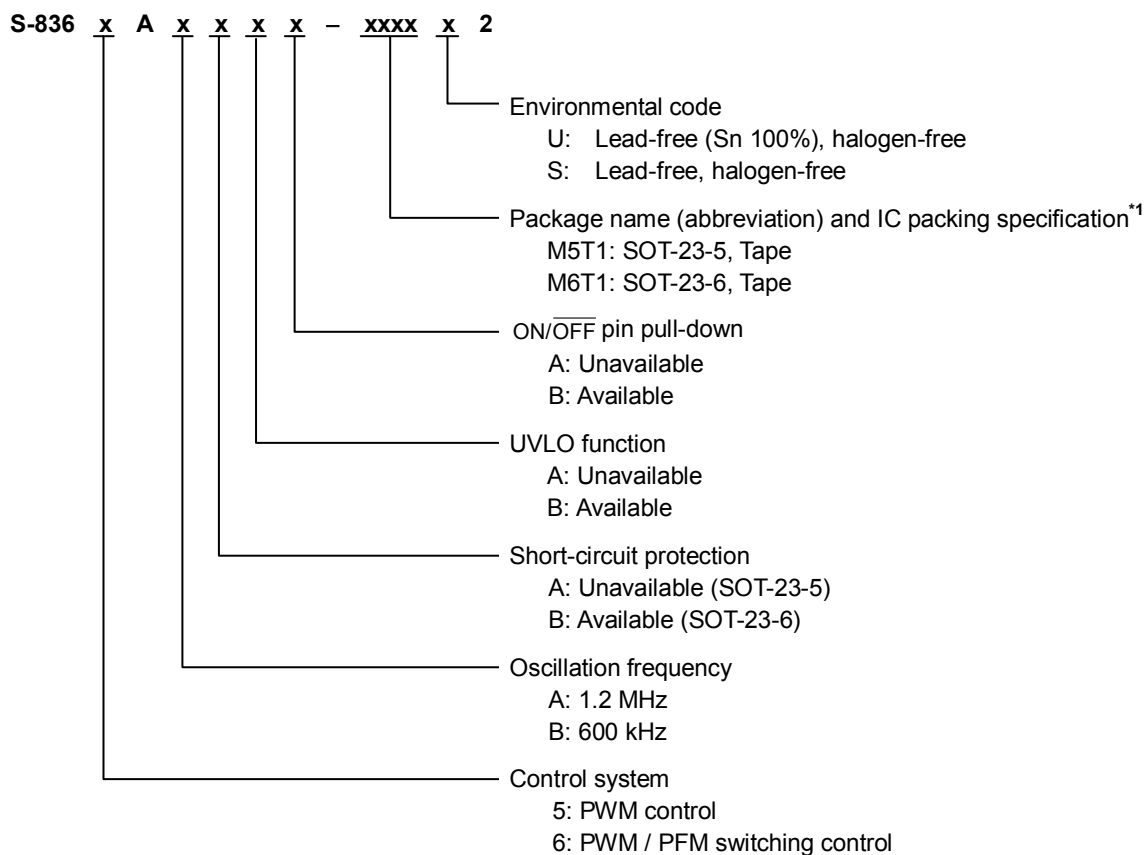

*1. Refer to the tape specification.

2. Package

Package name	Drawing code			
	Package	Tape	Reel	Land
SNT-6A	PG006-A-P-SD	PG006-A-C-SD	PG006-A-R-SD	PG006-A-L-SD
SOT-23-5	MP005-A-P-SD	MP005-A-C-SD	MP005-A-R-SD	–
SOT-23-6	MP006-A-P-SD	MP006-A-C-SD	MP006-A-R-SD	–

3. Product list

(1) S-8365 Series (PWM control)

Table 1

SOT-23-5	SOT-23-6	SNT-6A	Oscillation frequency	Short-circuit protection	UVLO function	ON/OFF pin pull-down
–	S-8365AABBA-M6T1y2	S-8365AABBA-I6T1x2	1.2 MHz	Available	Available	Unavailable
S-8365AAABA-M5T1y2	–	S-8365AAABA-I6T1x2	1.2 MHz	Unavailable	Available	Unavailable
S-8365AAAAA-M5T1y2	–	S-8365AAAAA-I6T1x2	1.2 MHz	Unavailable	Unavailable	Unavailable
–	S-8365ABBBA-M6T1y2	S-8365ABBBA-I6T1x2	600 kHz	Available	Available	Unavailable
S-8365ABABA-M5T1y2	–	S-8365ABABA-I6T1x2	600 kHz	Unavailable	Available	Unavailable
S-8365ABAAA-M5T1y2	–	S-8365ABAAA-I6T1x2	600 kHz	Unavailable	Unavailable	Unavailable

- Remark 1.** Contact our sales office for S-8365AxBAA (without UVLO function, with short-circuit protection).
2. Contact our sales office for S-8365AxxxB (ON/OFF pin pull-down).
3. x: G or U
 y: S or U
4. Please select products of environmental code = U for Sn 100%, halogen-free products.

(2) S-8366 Series (PWM / PFM switching control)

Table 2

SOT-23-5	SOT-23-6	SNT-6A	Oscillation frequency	Short-circuit protection	UVLO function	ON/OFF pin pull-down
–	S-8366AABBA-M6T1y2	S-8366AABBA-I6T1x2	1.2 MHz	Available	Available	Unavailable
S-8366AAABA-M5T1y2	–	S-8366AAABA-I6T1x2	1.2 MHz	Unavailable	Available	Unavailable
S-8366AAAAA-M5T1y2	–	S-8366AAAAA-I6T1x2	1.2 MHz	Unavailable	Unavailable	Unavailable
–	S-8366ABBBA-M6T1y2	S-8366ABBBA-I6T1x2	600 kHz	Available	Available	Unavailable
S-8366ABABA-M5T1y2	–	S-8366ABABA-I6T1x2	600 kHz	Unavailable	Available	Unavailable
S-8366ABAAA-M5T1y2	–	S-8366ABAAA-I6T1x2	600 kHz	Unavailable	Unavailable	Unavailable

- Remark 1.** Contact our sales office for S-8366AxBAA (without UVLO function, with short-circuit protection).
2. Contact our sales office for S-8366AxxxB (ON/OFF pin pull-down).
3. x: G or U
 y: S or U
4. Please select products of environmental code = U for Sn 100%, halogen-free products.

■ Pin Configurations

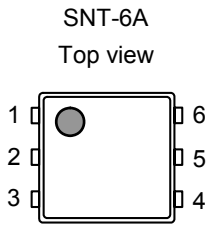

Figure 4

Table 3 With Short-Circuit Protection

Pin No.	Symbol	Description
1	EXT	External transistor connection pin
2	VSS	GND pin
3	ON/ $\overline{\text{OFF}}$	Power-off pin “H” : Power-on (normal operation) “L” : Power-off (standby)
4	FB	Output voltage feedback pin
5	CSP	Delay time setting pin for short-circuit protection
6	VDD	IC power supply pin

Table 4 Without Short-Circuit Protection

Pin No.	Symbol	Description
1	EXT	External transistor connection pin
2	VSS	GND pin
3	ON/ $\overline{\text{OFF}}$	Power-off pin “H” : Power-on (normal operation) “L” : Power-off (standby)
4	FB	Output voltage feedback pin
5	NC*1	No connection
6	VDD	IC power supply pin

*1. The NC pin indicates electrically open.
 The NC pin can be connected to VDD or VSS.

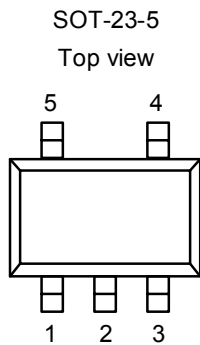

Figure 5

Table 5 Without Short-Circuit Protection

Pin No.	Symbol	Description
1	ON/ $\overline{\text{OFF}}$	Power-off pin “H” : Power-on (normal operation) “L” : Power-off (standby)
2	VSS	GND pin
3	EXT	External transistor connection pin
4	VDD	IC power supply pin
5	FB	Output voltage feedback pin

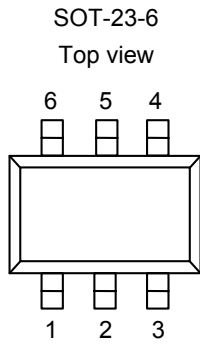

Figure 6

Table 6 With Short-Circuit Protection

Pin No.	Symbol	Description
1	VDD	IC power supply pin
2	CSP	Delay time setting pin for short-circuit protection
3	FB	Output voltage feedback pin
4	ON/ $\overline{\text{OFF}}$	Power-off pin "H" : Power-on (normal operation) "L" : Power-off (standby)
5	VSS	GND pin
6	EXT	External transistor connection pin

■ Absolute Maximum Ratings

Table 7 Absolute Maximum Ratings

(Ta = 25°C, VSS = 0 V unless otherwise specified)

Item	Symbol	Absolute Maximum Ratings	Unit
VDD pin voltage	V _{DD}	V _{SS} -0.3 to V _{SS} +6.0	V
FB pin voltage	V _{FB}	V _{SS} -0.3 to V _{DD} +0.3	V
EXT pin voltage	V _{EXT}	V _{SS} -0.3 to V _{DD} +0.3	V
ON/OFF pin voltage	V _{ON/OFF}	V _{SS} -0.3 to V _{DD} +0.3	V
CSP pin voltage	V _{CSP}	V _{SS} -0.3 to V _{DD} +0.3	V
Power dissipation	SNT-6A	400 ^{*1}	mW
	SOT-23-5	600 ^{*1}	mW
	SOT-23-6	650 ^{*1}	mW
Operating ambient temperature	T _{opr}	-40 to +85	°C
Storage temperature	T _{stg}	-40 to +125	°C

*1. When mounted on board

[Mounted board]

- (1) Board size : 114.3 mm × 76.2 mm × t1.6 mm
- (2) Name : JEDEC STANDARD51-7

Caution The absolute maximum ratings are rated values exceeding which the product could suffer physical damage. These values must therefore not be exceeded under any conditions.

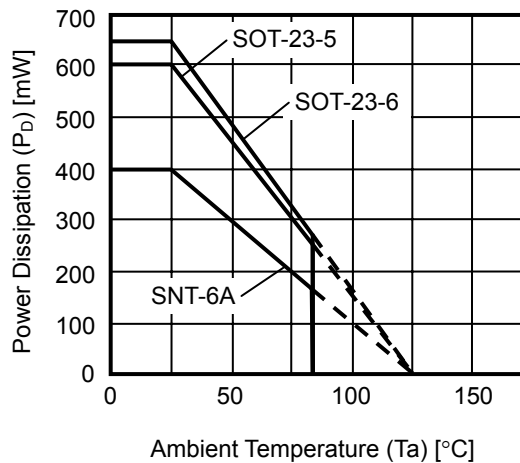

Figure 7 Package Power Dissipation (When Mounted on Board)

■ Electrical Characteristics

1. 1.2 MHz product

Table 8 Electrical Characteristics

($V_{DD} = 3.3\text{ V}$, $T_a = 25^\circ\text{C}$ unless otherwise specified)

Item	Symbol	Conditions	Min.	Typ.	Max.	Unit	Test Circuit
Input voltage* ¹	V_{DD}	–	1.8	–	5.5	V	2
Operating start voltage* ²	V_{ST1}	Product without UVLO function, $I_{OUT} = 1\text{ mA}$	–	–	1.1	V	3
Oscillation start voltage	V_{ST2}	No external parts for product without UVLO function,	–	–	1.0	V	1
Operation holding voltage	V_{HLD}	Product without UVLO function, $I_{OUT} = 1\text{ mA}$, Determined by decreasing V_{DD} gradually	0.8	–	–	V	3
FB voltage	V_{FB}	–	0.588	0.6	0.612	V	1
FB voltage temperature coefficient	$\frac{\Delta V_{FB}}{\Delta T_a}$	$T_a = -40^\circ\text{C}$ to $+85^\circ\text{C}$	–	± 100	–	ppm/ $^\circ\text{C}$	1
FB pin input current	I_{FB}	$V_{DD} = 1.8\text{ V}$ to 5.5 V , FB pin	-0.1	–	0.1	μA	1
Current consumption at operation* ³	I_{SS1}	At switching operation, no load $V_{FB} = V_{FB(S)} \times 0.95$	–	500	–	μA	1
Current consumption at switching off	I_{SS2}	At switching stop, $V_{FB} = V_{FB(S)} \times 1.5$	–	70	120	μA	1
Current consumption at shutdown	I_{SS3}	$V_{ON/OFF} = 0\text{ V}$	–	–	1.0	μA	1
EXT pin output current	I_{EXTH}	$V_{EXT} = V_{DD} - 0.4\text{ V}$	–	-130	-60	mA	1
	I_{EXTL}	$V_{EXT} = 0.4\text{ V}$	100	200	–	mA	1
Oscillation frequency	f_{osc}	–	1.0	1.2	1.4	MHz	1
Maximum duty ratio	Max Duty	$V_{FB} = V_{FB(S)} \times 0.95$	80	85	90	%	1
PWM / PFM switching Duty ratio* ⁴	PFM Duty	$V_{DD} = V_{OUT(S)} - 0.1\text{ V}$, no load	20	28	36	%	2
Short-circuit protection delay time* ⁵	t_{PRO}	Product with short-circuit protection, At $CSP = 0.1\text{ }\mu\text{F}$	37.5	50	75	ms	1
UVLO release voltage	V_{UVLO+}	Product with UVLO function	1.60	1.70	1.78	V	1
UVLO hysteresis width	$V_{UVLOHYS}$	Product with UVLO function	0.05	0.10	0.15	V	1
High level input voltage	V_{SH}	$V_{DD} = 1.8\text{ V}$ to 5.5 V , $\overline{ON/OFF}$ pin	0.75	–	–	V	1
Low level input voltage	V_{SL}	$V_{DD} = 1.8\text{ V}$ to 5.5 V , $\overline{ON/OFF}$ pin	–	–	0.3	V	1
High level input current	I_{SH}	Product without $\overline{ON/OFF}$ pin pull-down, $V_{DD} = 1.8\text{ V}$ to 5.5 V , $\overline{ON/OFF}$ pin	-0.1	–	0.1	μA	1
		Product with $\overline{ON/OFF}$ pin pull-down, $V_{DD} = 1.8\text{ V}$ to 5.5 V , $\overline{ON/OFF}$ pin	0.2	1.0	2.5	μA	1
Low level input current	I_{SL}	$V_{DD} = 1.8\text{ V}$ to 5.5 V , $\overline{ON/OFF}$ pin	-0.1	–	0.1	μA	1
Soft-start time	t_{SS}	–	5	7	10	ms	2

*1. The S-8365/8366 Series steps up from $V_{DD} = 1.1\text{ V}$, but set the input voltage as to $1.8\text{ V} \leq V_{DD} \leq 5.5\text{ V}$ for stabilizing the output voltage and oscillation frequency.

*2. This is the guaranteed value measured with external parts shown in “Table 10 External Parts List” and with test circuits shown in Figure 10. The operating start voltage varies largely depending on diode’s forward voltage. Evaluate sufficiently with actual device.

*3. $V_{FB(S)}$ is a setting value for FB voltage.

*4. $V_{OUT(S)}$ is a setting value for output voltage. V_{OUT} is the typical value of actual output voltage. $V_{OUT(S)}$ can be set by using the rate of V_{FB} and the output voltage setting resistors (R_{FB1} , R_{FB2}). For details, refer to “■ External Parts Selection”.

*5. The short-circuit protection time can be set by the external capacitor, and the maximum set value by the external capacitor is unlimited when an ideal case is assumed. But use $CSP =$ approximately $0.47\text{ }\mu\text{F}$ as a target maximum value due to the need to consider the discharge time of the capacitor. For details, refer to “■ External Parts Selection”.

2. 600 kHz product

Table 9 Electrical Characteristics

($V_{DD} = 3.3\text{ V}$, $T_a = 25^\circ\text{C}$ unless otherwise specified)

Item	Symbol	Conditions	Min.	Typ.	Max.	Unit	Test Circuit
Input voltage*1	V_{DD}	—	1.8	—	5.5	V	2
Operating start voltage*2	V_{ST1}	Product without UVLO function, $I_{OUT} = 1\text{ mA}$	—	—	1.0	V	3
Oscillation start voltage	V_{ST2}	No external parts for product without UVLO function,	—	—	0.9	V	1
Operation holding voltage	V_{HLD}	Product without UVLO function, $I_{OUT} = 1\text{ mA}$, Determined by decreasing V_{DD} gradually	0.8	—	—	V	3
FB voltage	V_{FB}	—	0.588	0.6	0.612	V	1
FB voltage temperature coefficient	$\frac{\Delta V_{FB}}{\Delta T_a}$	$T_a = -40^\circ\text{C}$ to $+85^\circ\text{C}$	—	± 100	—	ppm/ $^\circ\text{C}$	1
FB pin input current	I_{FB}	$V_{DD} = 1.8\text{ V}$ to 5.5 V , FB pin	-0.1	—	0.1	μA	1
Current consumption at operation*3	I_{SS1}	At switching operation, no load $V_{FB} = V_{FB(S)} \times 0.95$	—	300	—	μA	1
Current consumption at switching off	I_{SS2}	At switching stop, $V_{FB} = V_{FB(S)} \times 1.5$	—	70	120	μA	1
Current consumption at shutdown	I_{SSS}	$V_{ON}/\overline{\text{OFF}} = 0\text{ V}$	—	—	1.0	μA	1
EXT pin output current	I_{EXTH}	$V_{EXT} = V_{DD} - 0.4\text{ V}$	—	-130	-60	mA	1
	I_{EXTL}	$V_{EXT} = 0.4\text{ V}$	100	200	—	mA	1
Oscillation frequency	f_{osc}	—	510	600	690	kHz	1
Maximum duty ratio	Max Duty	$V_{FB} = V_{FB(S)} \times 0.95$	85	90	95	%	1
PWM / PFM switching Duty ratio*4	PFM Duty	$V_{DD} = V_{OUT(S)} - 0.1\text{ V}$, no load	20	28	36	%	2
Short-circuit protection delay time*5	t_{PRO}	Product with short-circuit protection, At $CSP = 0.1\text{ }\mu\text{F}$	37.5	50	75	ms	1
UVLO release voltage	V_{UVLO+}	Product with UVLO function	1.60	1.70	1.78	V	1
UVLO hysteresis width	$V_{UVLOHYS}$	Product with UVLO function	0.05	0.10	0.15	V	1
High level input voltage	V_{SH}	$V_{DD} = 1.8\text{ V}$ to 5.5 V , $\text{ON}/\overline{\text{OFF}}$ pin	0.75	—	—	V	1
Low level input voltage	V_{SL}	$V_{DD} = 1.8\text{ V}$ to 5.5 V , $\text{ON}/\overline{\text{OFF}}$ pin	—	—	0.3	V	1
High level input current	I_{SH}	Product without $\text{ON}/\overline{\text{OFF}}$ pin pull-down, $V_{DD} = 1.8\text{ V}$ to 5.5 V , $\text{ON}/\overline{\text{OFF}}$ pin	-0.1	—	0.1	μA	1
		Product with $\text{ON}/\overline{\text{OFF}}$ pin pull-down, $V_{DD} = 1.8\text{ V}$ to 5.5 V , $\text{ON}/\overline{\text{OFF}}$ pin	0.2	1.0	2.5	μA	1
Low level input current	I_{SL}	$V_{DD} = 1.8\text{ V}$ to 5.5 V , $\text{ON}/\overline{\text{OFF}}$ pin	-0.1	—	0.1	μA	1
Soft-start time	t_{SS}	—	5	7	10	ms	2

*1. The S-8365/8366 Series steps up from $V_{DD} = 1.0\text{ V}$, but set the input voltage as to $1.8\text{ V} \leq V_{DD} \leq 5.5\text{ V}$ for stabilizing the output voltage and oscillation frequency.

*2. This is the guaranteed value measured with external parts shown in “Table 10 External Parts List” and with test circuits shown in Figure 10. The operating start voltage varies largely depending on diode’s forward voltage. Evaluate sufficiently with actual device.

*3. $V_{FB(S)}$ is a setting value for FB voltage.

*4. $V_{OUT(S)}$ is a setting value for output voltage. V_{OUT} is the typical value of actual output voltage. $V_{OUT(S)}$ can be set by using the rate of V_{FB} and the output voltage setting resistors (R_{FB1} , R_{FB2}). For details, refer to “External Parts Selection”.

*5. The short-circuit protection time can be set by the external capacitor, and the maximum set value by the external capacitor is unlimited when an ideal case is assumed. But use $CSP = \text{approximately } 0.47\text{ }\mu\text{F}$ as a target maximum value due to the need to consider the discharge time of the capacitor. For details, refer to “External Parts Selection”.

■ External Parts List When Measuring Electrical Characteristics

Table 10 External Parts List

Element Name	Symbol	Consonants	Manufacturer	Part Number
Inductor	L	2.2 μ H (1.2 MHz product)	TAIYO YUDEN Co., Ltd.	NR6028T
		3.3 μ H (600 kHz product)	TDK Corporation	LTF5022
Transistor	M1	–	Vishay Intertechnology, Inc.	Si3460BDV
	Q1	–	TOSHIBA CORPORATION	2SD2652
Diode	SD	–	SHINDENGEN ELECTRIC MANUFACTURING CO.,LTD	D1FH3
Input capacitor	C _{IN}	10 μ F	TDK Corporation	C3225X7R1E106MB
Output capacitor	C _{OUT}	22 μ F	TDK Corporation	C4532X7R1E226MB
FB pin capacitor	C _{FB}	47 pF	Murata Manufacturing Co., Ltd.	GRM1882C1H series
CSP pin capacitor	CSP	0.1 μ F	TDK Corporation	C1220X7R1E104MB
Speed-up capacitor	C _b	2200 pF	TDK Corporation	C1005X7R1H222K
Base resistor	R _b	1 k Ω	ROHM Co., Ltd.	MCR03 series
Output voltage setting resistor 1	R _{FB1}	220 k Ω	ROHM Co., Ltd.	MCR03 series
Output voltage setting resistor 2	R _{FB2}	30 k Ω	ROHM Co., Ltd.	MCR03 series

■ Test Circuits

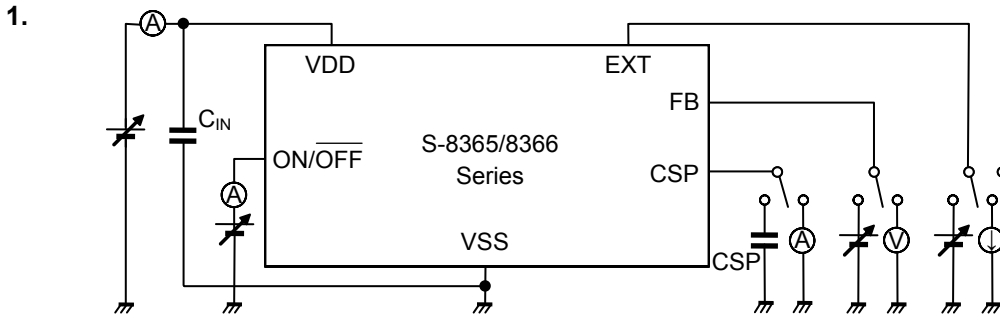

Figure 8

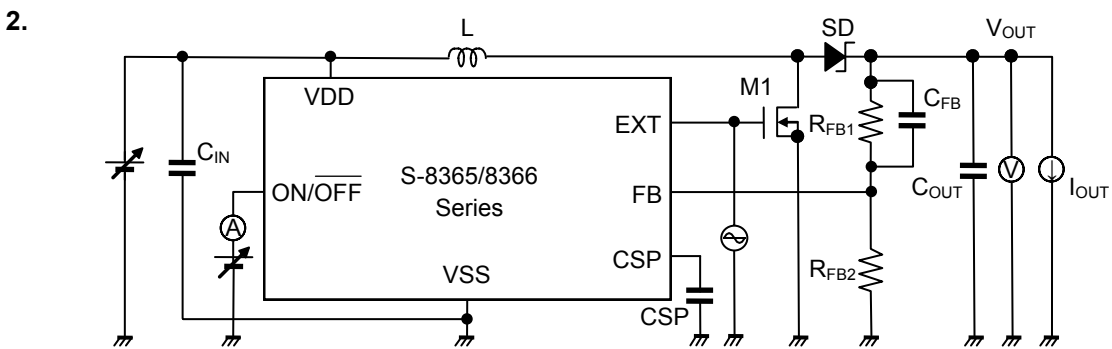

Figure 9

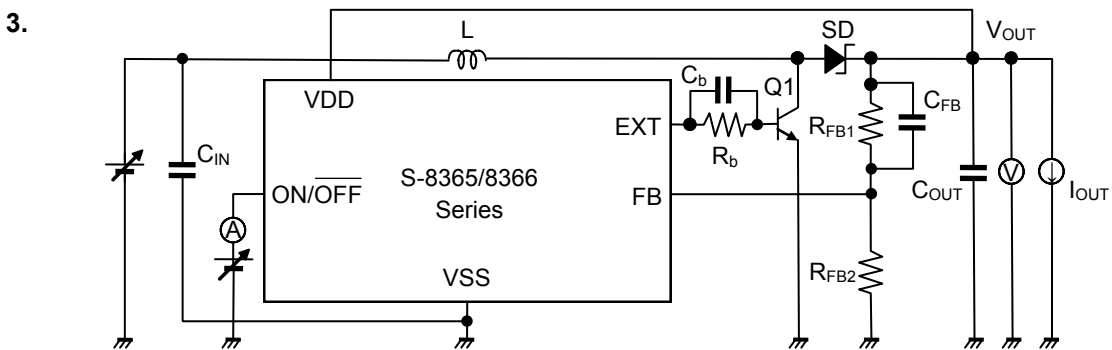

Figure 10

■ Operation

1. Switching control method

1.1 PWM control (S-8365 Series)

The S-8365 Series is a switching regulator controller that uses a pulse width modulation method (PWM).

In conventional PWM control switching regulators, pulses are skipped when the output load current is small, causing a fluctuation in the ripple frequency of the output voltage, resulting in increased ripple voltage.

For the S-8365 Series, although the pulse width changes from 0% to 90% in accordance with each load current (or 0% to 85% for 1.2 MHz products), since the switching frequency does not change, the ripple voltage generated due to switching can be eliminated by filtering. The ripple voltage can thus be lowered in the wide input voltage and load current ranges.

1.2 PWM / PFM switching control (S-8366 Series)

The S-8366 Series switching regulator controller automatically switches between the pulse width modulation method (PWM) and pulse frequency modulation method (PFM) according to the load current.

A low ripple power can be supplied by operating on PWM control for which the pulse width changes from 28% to 90% (or 28% to 85% for 1.2 MHz products) in the range where the output load current is large.

The S-8366 Series operates on PFM control when the output load current is small and the fixed pulses which have the width of 28% are skipped according to the load current amount. Therefore, the oscillation circuit intermittently oscillates, reducing the self-current consumption. This avoids decreased efficiency when the output load current is small. The point at which PWM control switches to PFM control varies depending on the external element (inductor, diode, etc.), input voltage value, and output voltage value, and this method achieves high efficiency in the output load current of about 100 μ A.

2. Soft-start function

The S-8365/8366 Series has a soft-start circuit. The output voltage (V_{OUT}) gradually rises after power-on or startup when the ON/OFF pin is set to high, suppressing rush current and overshooting the output voltage. The soft-start time (t_{SS}) for the S-8365/8366 Series is defined as the time from startup until V_{OUT} reaches 90% of the output set voltage value ($V_{OUT(S)}$). A reference voltage adjustment method is used as the soft-start method and the reference voltage gradually rises from 0 V after soft-start.

A soft-start performs by controlling the FB pin voltage so that it follows the rise of the reference voltage. After the reference voltage rises once, it is reset to 0 if the ON/OFF pin voltage drops to low, the power supply voltage drops to the UVLO detection voltage, or the S-8365/8366 Series enters the short-circuit protection latch status. A soft-start is performed regardless of conditions when resuming step-up operation.

3. Shutdown pin

This pin stops or starts step-up operations.

3.1 Without ON/OFF pin pull-down

When this pin is set to the low level, the voltage of the EXT pin is fixed to 0 V, and the external transistor and all internal circuits stop, substantially reducing the current consumption.

Do not use the ON/OFF pin in a floating state because it is set up as shown in **Figure 11** and is not internally pulled up or down. Do not apply a voltage of between 0.3 V and 0.75 V to the ON/OFF pin because applying such a voltage increases the current consumption. If the ON/OFF pin is not used, connect it to the VDD pin.

Table 11

ON/OFF pin	CR Oscillation Circuit	Output Voltage
“H”	Operates	Set value
“L”	Stops	$\cong V_{IN}^{*1}$

*1. Voltage obtained by subtracting the voltage drop due to the DC resistance of the inductor and the diode forward voltage from V_{IN} .

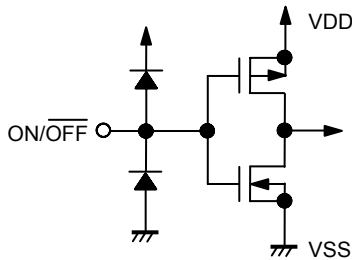

Figure 11

3.2 With ON/OFF pin pull-down

When the ON/OFF pin is set to the low level, the voltage of the EXT pin is fixed to 0 V, and the external transistor and all internal circuits stop substantially reducing the current consumption.

The ON/OFF pin is set up as shown in **Figure 12** and is internally pulled down by using the depression transistor, so all circuits stop even if this pin is floating. Do not apply a voltage of between 0.3 V and 0.75 V to the ON/OFF pin because applying such a voltage increases the current consumption. If the ON/OFF pin is not used, connect it to the VDD pin.

Table 12

ON/OFF Pin	CR Oscillation Circuit	Output Voltage
“H”	Operates	Set value
“L”	Stops	$\cong V_{IN}^{*1}$
High-Z	Stops	$\cong V_{IN}^{*1}$

*1. Voltage obtained by subtracting the voltage drop due to the DC resistance of the inductor and the diode forward voltage from V_{IN} .

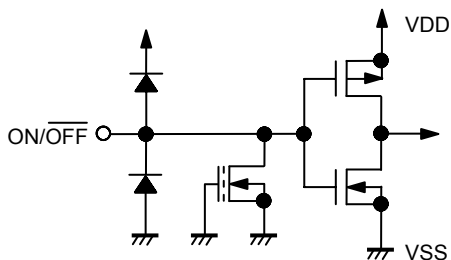

Figure 12

4. Timer latch type short-circuit protection (products with short-circuit protection function)

The S-8365/8366 Series incorporates a timer latch type short-circuit protection circuit that stops switching operation if the output short circuits for a certain time or more. Connect a capacitor (CSP) to the CSP pin to set the delay time of this circuit.

The S-8365/8366 Series operates on the maximum duty if the output voltage drops due to output short-circuiting or other factors. When it enters the maximum duty status, charging the constant current to CSP is started. If this status is held for the short-circuit protection delay time or more, the voltage of the CSP pin exceeds the reference voltage and the IC enters the latch mode.

Note that switching operation stops in latch mode but the internal circuits normally operate, which differs from the power-off status. The constant current is continuously charged to CSP even in latch mode, so the voltage of the CSP pin rises to the V_{DD} level.

To reset the latch mode of short-circuit protection, lower V_{DD} to the UVLO detection voltage or lower or set the ON/OFF pin to the low level.

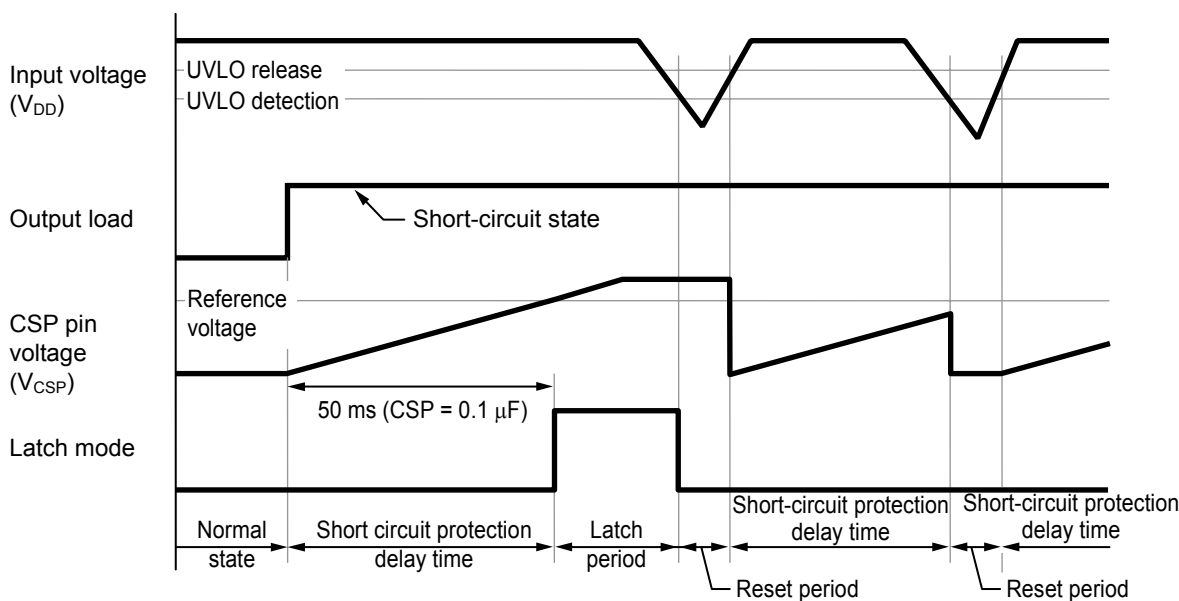

Figure 13

5. UVLO function (products with UVLO function)

The S-8365/8366 Series has a UVLO (undervoltage lockout) circuit for avoiding IC malfunctions due to power supply voltage drops. The S-8365/8366 Series stops switching operation upon UVLO detection and retains the external transistor in the off state. After entering the UVLO detection status once, the soft-start function is reset.

Note, however, that the other internal circuits operate normally and that the status differs from the power-off status.

■ Operation Principles

The S-8365/8366 Series is a step-up switching regulator controller. **Figure 14** shows the basic circuit diagram. Step-up switching regulators start current supply by the input voltage (V_{IN}) when the Nch power MOS FET is turned on and holds energy in the inductor at the same time. When the Nch power MOS FET is turned off, the CONT pin voltage is stepped up to discharge the energy held in the inductor and the current is discharged to V_{OUT} through the diode. When the discharged current is stored in C_L , a voltage is generated, and the potential of V_{OUT} increases until the voltage of the FB pin reaches the same potential as the internal reference voltage. For the PWM control method, the switching frequency (f_{OSC}) is fixed and the V_{OUT} voltage is held constant according to the ratio of the ON time and OFF time (ON duty) of the Nch power MOS FET in each period. For the PFM control method, the V_{OUT} voltage is held constant by controlling the ON time. In the S-8366 Series, the Nch power MOS FET is turned on when the fixed duty cycle is 28% for the PFM control method. When energy is discharged to V_{OUT} once and the V_{OUT} potential exceeds the set value, the Nch power MOS FET stays in the off status until V_{OUT} decreases to the set value or less due to the load discharge. Time V_{OUT} decreases to the set value or less depends on the amount of load current, so, the switching frequency varies depending on this current.

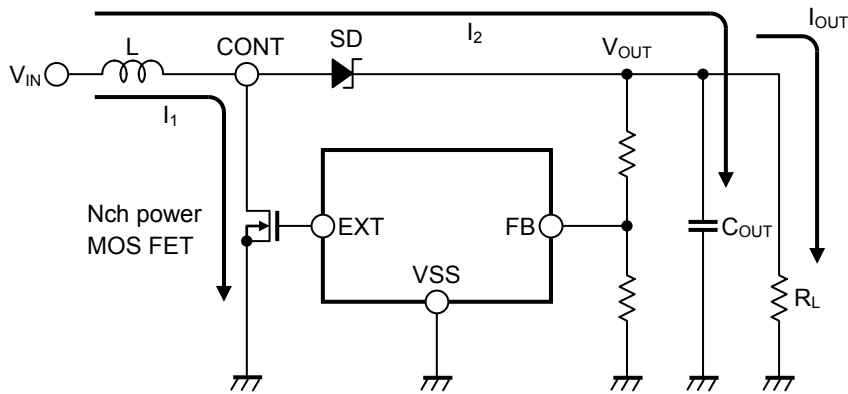

Figure 14 Basic Circuit of Step-up Switching Regulator

The ON duty in the current continuous mode can be calculated by using the equation below. Use the S-8365/8366 Series in the range where the ON duty is less than the maximum duty. Note that the products with short-circuit protection is set in the timer-latch status if the maximum duty lasts the short-circuit protection delay time (t_{PRO}) or more.

The maximum duty is 85% typ. for 1.2 MHz products and 90% for 600 kHz products.

$$\text{ON duty} = \left(1 - \frac{V_{IN}}{V_{OUT} + V_D}\right) \times 100 \text{ [\%]}$$

The ON time (t_{ON}) can be calculated by using the following equation :

$$\begin{aligned} t_{ON} &= \frac{1}{f_{OSC}} \times \text{ON duty} \\ &= \frac{1}{f_{OSC}} \times \left(1 - \frac{V_{IN}}{V_{OUT} + V_D}\right) \dots\dots\dots (1) \end{aligned}$$

*1. V_D : Forward voltage of diode

1. Continuous current mode

The following explains the current that flows into the inductor when the step-up operation stabilizes in a certain status and I_{OUT} is sufficiently large.

When the Nch power MOS FET is turned on, current (I_1) flows in the direction shown in **Figure 14**. The inductor current (I_L) at this time gradually increases in proportion with the ON time (t_{ON}) of the Nch power MOS FET.

Current change of inductor within t_{ON} :

$$\begin{aligned} \Delta I_{L(ON)} &= I_L \text{ max.} - I_L \text{ min.} \\ &= \frac{V_{IN}}{L} \times t_{ON} \end{aligned}$$

When the Nch power MOS FET is turned off, the voltage of the CONT pin is stepped up to $V_{OUT} + V_D$ and the voltage on both ends of the inductor becomes $V_{OUT} + V_D - V_{IN}$. However, it is assumed here that $V_{OUT} \gg V_D$ and V_D is ignored.

Current change of inductor within t_{OFF} :

$$\Delta I_{L(OFF)} = \frac{V_{OUT} - V_{IN}}{L} \times t_{OFF}$$

The input power equals the output power in an ideal situation where there is no loss by components.

$I_{IN(AV)}$:

$$\begin{aligned} P_{IN} &= P_{OUT} \\ I_{IN(AV)} \times V_{IN} &= I_{OUT} \times V_{OUT} \\ \therefore I_{IN(AV)} &= \frac{V_{OUT}}{V_{IN}} \times I_{OUT} \dots\dots\dots (2) \end{aligned}$$

The current that flows in the inductor consists of a ripple current that changes due to variation over time and a direct current.

From **Figure 15** :

$I_{IN(AV)}$:

$$\begin{aligned} I_{IN(AV)} &= I_{IN(DC)} + \frac{\Delta I_L}{2} \\ &= I_{IN(DC)} + \frac{V_{OUT} - V_{IN}}{2 \times L} \times t_{OFF} \\ &= I_{IN(DC)} + \frac{V_{IN}}{2 \times L} \times t_{ON} \dots\dots\dots (3) \end{aligned}$$

Above, the continuous mode is the operation mode when $I_{IN(DC)} > 0$ as shown in **Figure 15** and the inductor current continuously flows.

While the output current (I_{OUT}) continues to decrease, $I_{IN(DC)}$ reaches 0 as shown in **Figure 16**. This point is the critical point of the continuous mode.

As shown in equations (2) and (3), the direct current component ($I_{IN(DC)}$) depends on I_{OUT} .

$I_{OUT(0)}$ when $I_{IN(DC)}$ reaches 0 (critical point) :

$$I_{OUT(0)} = \frac{t_{ON} \times V_{IN}^2}{2 \times L \times V_{OUT}}$$

t_{ON} can be calculated using equation (1).

When the output current decreases below $I_{OUT(0)}$, the current flowing in the inductor stops flowing in the t_{OFF} period as shown in **Figure 17**. This is the discontinuous mode.

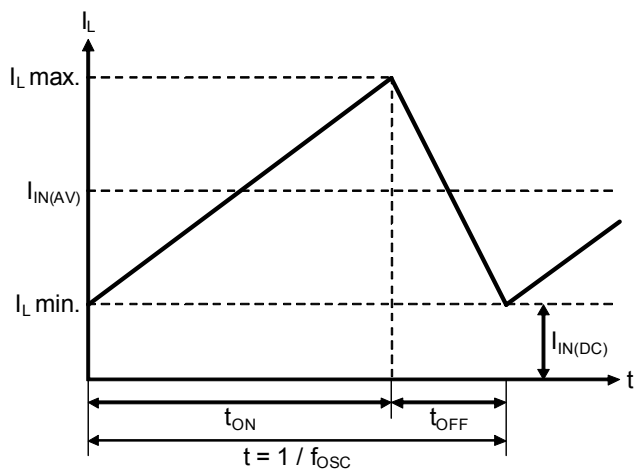

Figure 15 Continuous Mode (Current Cycle of Inductor Current I_L)

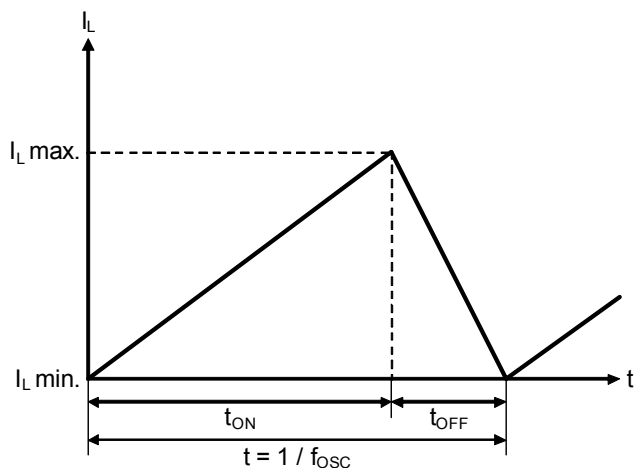

Figure 16 Critical Point (Current Cycle of Inductor Current I_L)

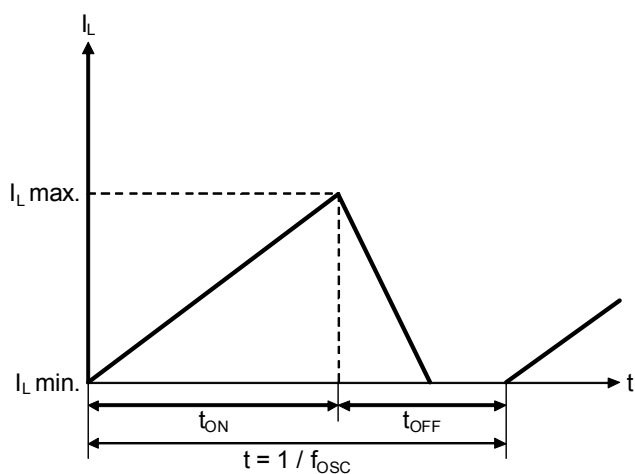

Figure 17 Discontinuous Mode (Current Cycle of Inductor Current I_L)

External Parts Selection

1. Inductor

The recommended L value of the S-8365/8366 Series is 2.2 μH for 1.2 MHz products and 3.3 μH for 600 kHz products.

Note the following when changing the inductance.

The inductance (L) has a strong influence on the maximum output current (I_{OUT}) and efficiency (η).

The inductor peak current (I_{PK}) increases when L is decreased, which improves the circuit stability and increases the I_{OUT} users can obtain. If L is decreased further, the ability of the external transistor to drive the current becomes insufficient, reducing the efficiency and decreasing I_{OUT}.

The loss due to the I_{PK} of the switching transistor is decreased by increasing L and the efficiency maximizes at a certain L value. If L is increased further, the loss due to the serial resistance of the inductor increases, lowering the efficiency.

Caution When selecting an inductor, be careful about its allowable current. If a current exceeding the allowable current flows through the inductor, magnetic saturation occurs, substantially lowering the efficiency and destroying ICs due to large current. Therefore, select an inductor such that I_{PK} does not exceed the allowable current. The following equations express I_{PK} in the ideal statuses in the discontinuous and continuous modes :

$$I_{PK} = \sqrt{\frac{2 \times I_{OUT} \times (V_{OUT} + V_D^{*2} - V_{IN})}{f_{OSC}^{*1} \times L}} \quad (\text{Discontinuous mode})$$

$$I_{PK} = \frac{V_{OUT} + V_D^{*2}}{V_{IN}} \times I_{OUT} + \frac{(V_{OUT} + V_D^{*2} - V_{IN}) \times V_{IN}}{2 \times (V_{OUT} + V_D^{*2}) \times f_{OSC}^{*1} \times L} \quad (\text{Continuous mode})$$

*1. f_{OSC} : oscillation frequency

*2. V_D is the forward voltage of a diode. The reference value is 0.4 V.

However, current exceeding the above equation flows because conditions are practically not ideal. Perform sufficient evaluation with actual application.

Table 13 Typical Inductors (for Small Low-Profile Devices)

Manufacture	Product Name	L Value	DC Resistance	Rated Current	Dimensions (L × W × H) [mm]
TDK Corporation	VLF3010ST-2R2M	2.2 μH	0.092 Ω max.	1.1 A max.	2.8 × 3.0 × 1.0
	VLF3010ST-3R3M	3.3 μH	0.130 Ω max.	0.88 A max.	2.8 × 3.0 × 1.0
	VLS252010-2R2M	2.2 μH	0.190 Ω max.	1.2 A max.	2.5 × 2.0 × 1.0
	VLS252010-3R3M	3.3 μH	0.304 Ω max.	1.0 A max.	2.5 × 2.0 × 1.0
Coilcraft, Inc.	LPS3008-222ML	2.2 μH	0.175 Ω max.	1.1 A max.	3.0 × 3.0 × 0.8
	LPS3008-332ML	3.3 μH	0.285 Ω max.	0.88 A max.	3.0 × 3.0 × 0.8
Taiyo Yuden Co., Ltd.	NR3010T2R2M	2.2 μH	0.114 Ω max.	1.1 A max.	3.0 × 3.0 × 1.0
	NR3010T3R3M	3.3 μH	0.168 Ω max.	0.87 A max.	3.0 × 3.0 × 1.0
Sumida Corporation	CDRH2D11BNP-2R2N	2.2 μH	0.0955 Ω max.	1.4 A max.	3.0 × 3.0 × 1.2
	CDRH2D11BNP-3R3N	3.3 μH	0.154 Ω max.	1.0 A max.	3.0 × 3.0 × 1.2

Table 14 Typical Inductors (for Large Current, High Step-up Rate)

Manufacture	Product Name	L Value	DC Resistance	Rated Current	Dimensions (L × W × H) [mm]
TDK Corporation	LTF5022T-2R2M	2.2 μH	0.040 Ω max.	3.4 A max.	5.0 × 5.2 × 2.2
	LTF5022T-3R3M	3.3 μH	0.060 Ω max.	2.7 A max.	5.0 × 5.2 × 2.2
Coilcraft, Inc.	LPS6225-222ML	2.2 μH	0.045 Ω max.	4.1 A max.	6.0 × 6.0 × 2.4
	LPS6225-332ML	3.3 μH	0.055 Ω max.	3.6 A max.	6.0 × 6.0 × 2.4
Taiyo Yuden Co., Ltd.	NR6028T2R2M	2.2 μH	0.020 Ω max.	4.2 A max.	6.0 × 6.0 × 2.8

2. Diode

Use an externally mounted that meets the following conditions.

- Low forward voltage (Schottky barrier diode or similar type)
- High switching speed
- Reverse withstand voltage of V_{OUT} + spike voltage or more
- Rated current of I_{PK} or more

3. Input capacitor (C_{IN}) and output capacitor (C_{OUT})

To improve efficiency, an input capacitor (C_{IN}) lowers the power supply impedance and averages the input current. Select C_{IN} according to the impedance of the power supply used. The recommended capacitance is 10 μ F for the S-8365/8366 Series.

An output capacitor (C_{OUT}), which is used to smooth the output voltage, requires a capacitance larger than that of the step-down type because the current is intermittently supplied from the input to the output side in the step-up type. A 22 μ F ceramic capacitor is recommended for the S-8365/8366 Series. However, a higher capacitance is recommended if the output voltage is high or the load current is large. If the output voltage or load current is low, about 10 μ F can be used without problems.

Select C_{OUT} after sufficient evaluation with actual application.

A ceramic capacitor can be used for both the input and output.

4. Capacitor for setting short-circuit protection delay time (CSP) (products with short-circuit protection)

For the S-8365/8366 Series, the short-circuit protection delay time can be set to any value by using an external capacitor. Connect the capacitor between the CSP and VSS pins. Select the capacitor value according to the equation below and **Figure 18**.

Note, however, that the equation and figure show a theoretical value assuming an ideal capacitor value and typ. IC conditions. Variations of the capacitor and IC are not considered.

For the IC variations, see the short-circuit protection delay time (t_{PRO}) in "■ Electrical Characteristics".

$$CSP [\mu F] \cong \frac{t_{PRO} [ms] \times 1.2 \times 10^{-3}}{0.6}$$

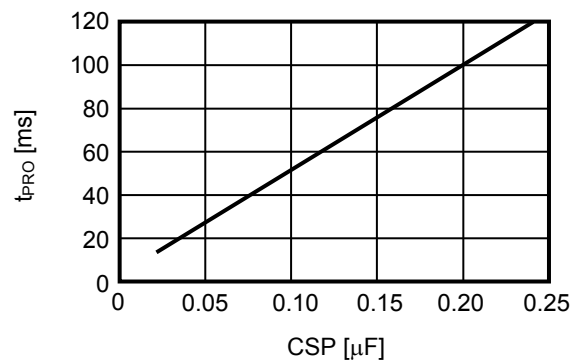

Figure 18 CSP vs. t_{PRO}

5. External transistor

A bipolar (NPN) or enhanced (Nch) MOS FET transistor can be used as an external transistor.

5.1 Bipolar NPN type

The driving ability to increase output current by using a bipolar transistor is determined based on the h_{FE} value and R_b value of the bipolar transistor. **Figure 19** shows the peripheral circuit.

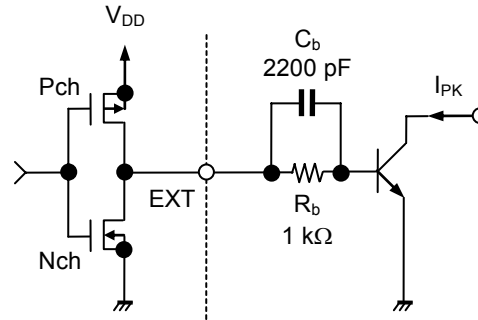

Figure 19 External Transistor Peripheral Circuit

The recommended R_b value is around 1 kΩ. Calculate the required base current (I_b) based on the h_{FE} value of the bipolar transistor by using $I_b = \frac{I_{PK}}{h_{FE}}$, and then select an R_b value smaller than that determined using:

$$R_b = \frac{V_{DD} - 0.7}{I_b} - \frac{0.4}{|I_{EXTH}|}$$

Smaller R_b values increase the output current, but decrease the efficiency. Actually, the current might flow on pulses or the V_{DD} or V_{SS} voltage might drop due to wiring resistance, so determine the optimum value based on experimentation.

Inserting a speed-up capacitor (C_b) in parallel with the R_b resistor as shown in **Figure 19** reduces switching loss and increases efficiency.

Select a speed-up capacitor for which the C_b value satisfies $C_b \leq \frac{1}{2 \times \pi \times R_b \times f_{OSC} \times 0.7}$.

Actually, however, the optimum C_b value varies depending on the characteristics of the bipolar transistor used, so determine the optimum value based on experimentation.

5.2 Enhanced MOS FET type

Use an Nch power MOS FET. A MOS FET that has low ON-resistance (R_{ON}) and input capacitance (C_{ISS}) is ideal for gaining efficiency. The ON-resistance and input capacitance generally have a tradeoff relationship. ON-resistance is efficient in the range where the output current is high with relatively low frequency switching, and input capacitance is efficient in the range where the output current is medium to low with high frequency switching. Therefore, select a MOS FET for which the ON-resistance and input capacitance are optimum under your usage conditions.

The input voltage (V_{DD}) is supplied as the gate voltage of a MOS FET, so select a MOS FET for which the gate withstand voltage is higher than the maximum value used for the input voltage, and for which the drain withstand voltage is greater than or equal to the output voltage (V_{OUT}) + the forward voltage of the diode (V_D).

If a MOS FET for which the threshold value is near the UVLO detection voltage is used, a high current flows upon power-on, and, in the worst case, the output voltage might not increase and the timer latch type short-circuit protection circuit might operate. Therefore, select a MOS FET for which the threshold value is sufficiently lower than the UVLO detection voltage.

6. Output voltage setting resistors (R_{FB1} , R_{FB2}), capacitor for phase compensation (C_{FB})

For the S-8365/8366 Series, V_{OUT} can be set to any value by using external divider resistors. Connect the divider resistors between the VOUT and VSS pins.

Because $V_{FB} = 0.6$ V typ., V_{OUT} can be calculated by using the following equation :

$$V_{OUT} = \frac{R_{FB1} + R_{FB2}}{R_{FB2}} \times 0.6$$

Connect divider resistors R_{FB1} and R_{FB2} as close to the IC as possible to minimize the effects of noise. If noise has an effect, adjust the values of R_{FB1} and R_{FB2} so that $R_{FB1} + R_{FB2} < 100$ k Ω .

C_{FB} , which is connected in parallel with R_{FB1} , is a capacitor for phase compensation.

By setting the zero point (the phase feedback) by adding capacitor C_{FB} to output voltage setting resistor R_{FB1} in parallel, the phase margin increases, improving the stability of the feedback loop. To effectively use the feedback portion of the phase based on the zero point, define C_{FB} by using the following equation :

$$C_{FB} \cong \frac{\sqrt{L \times C_{OUT}}}{3 \times R_{FB1}} \times \frac{V_{OUT}}{V_{DD}}$$

This equation is only a guide.

The following explains the optimum setting.

To efficiently use the feedback portion of the phase based on the zero point, specify settings so that the phase feeds back at the zero point frequency (f_{zero}) of R_{FB1} and C_{FB} according to the phase delay at the pole frequency (f_{pole}) of L and C_{OUT} . The zero point frequency is generally set slightly higher than the pole frequency.

The following equations are used to determine the pole frequency of L and C_{OUT} and the zero point frequency set using R_{FB1} and C_{FB} .

$$f_{pole} \cong \frac{1}{2 \times \pi \times \sqrt{L \times C_{OUT}}} \times \frac{V_{DD}}{V_{OUT}}$$

$$f_{zero} \cong \frac{1}{2 \times \pi \times R_{FB1} \times C_{FB}}$$

The transient response can be improved by setting the zero point frequency in a lower frequency range. If, however, the zero point frequency is set in a significantly lower range, the gain increases in the range of high frequency and the phase margin decreases. This might result in unstable operation. Determine the proper value after sufficient evaluation with actual application.

The typical constants based on our evaluation are shown in **Table 15**.

Table 15 Example of Constant for External Parts

$V_{OUT(S)}$ [V]	V_{DD} [V]	R_{FB1} [k Ω]	R_{FB2} [k Ω]	C_{FB} [pF]	L [μ H]	C_{OUT} [μ F]
1.8	1.2	30	15	100	3.3	10
1.8	1.2	30	15	82	2.2	10
3.32	1.2	68	15	82	3.3	10
3.32	1.2	68	15	68	2.2	10
5.0	1.8	110	15	68	3.3	22
5.0	1.8	110	15	56	2.2	22
9.0	3.3	210	15	39	3.3	22
9.0	3.3	210	15	33	2.2	22
15.0	3.3	360	15	39	3.3	22
15.0	3.3	360	15	33	2.2	22

■ Standard Circuit

(1) With short-circuit protection (SNT-6A, SOT-23-6)

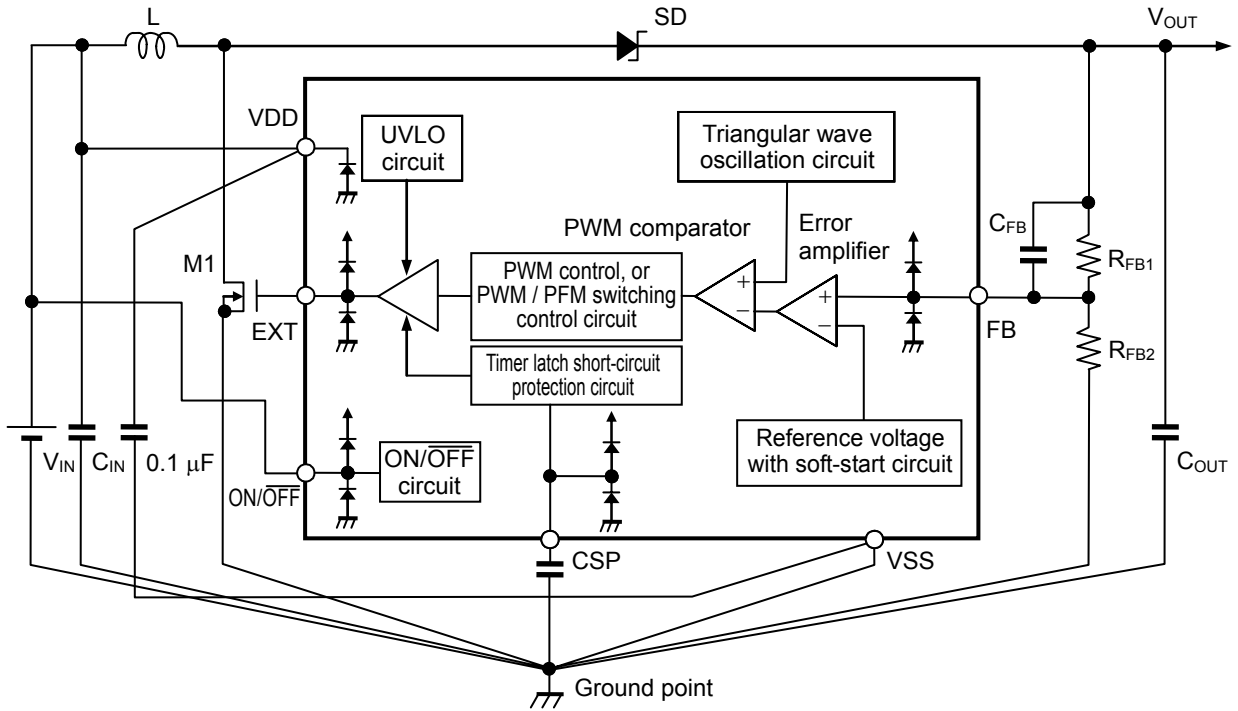

Figure 20

(2) Without short-circuit protection (SOT-23-5)

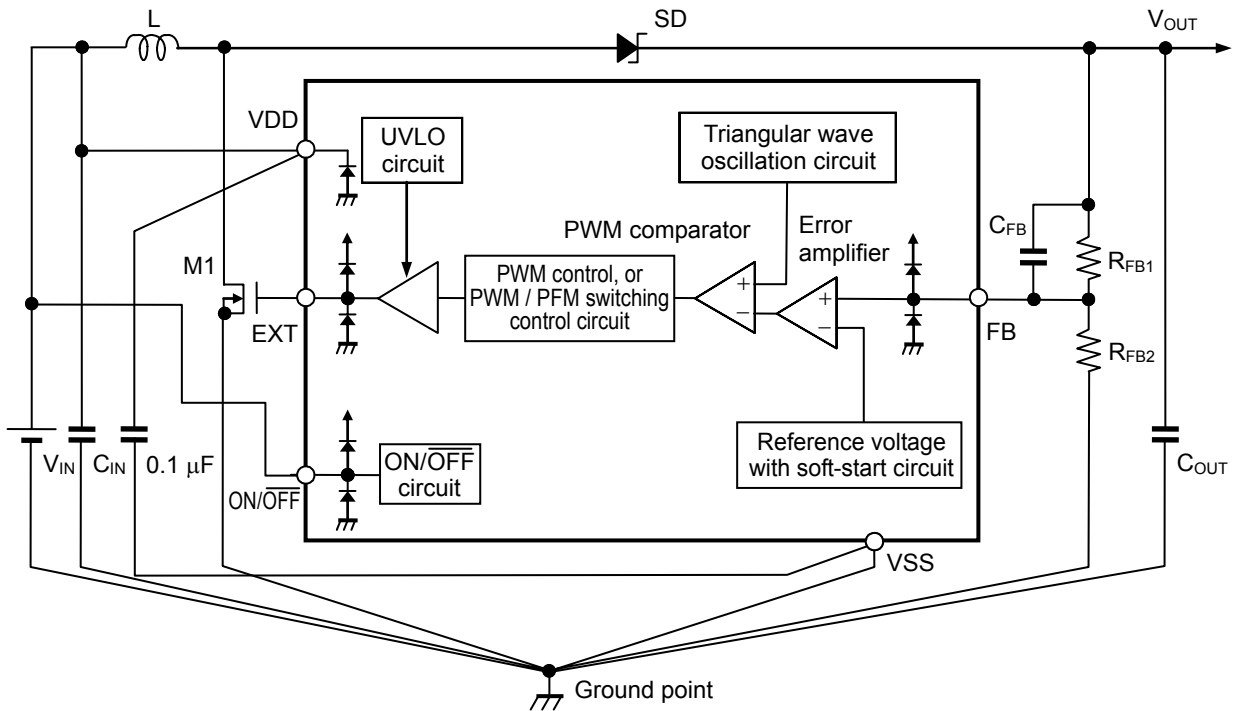

Figure 21

(3) Low input voltage (SOT-23-5)

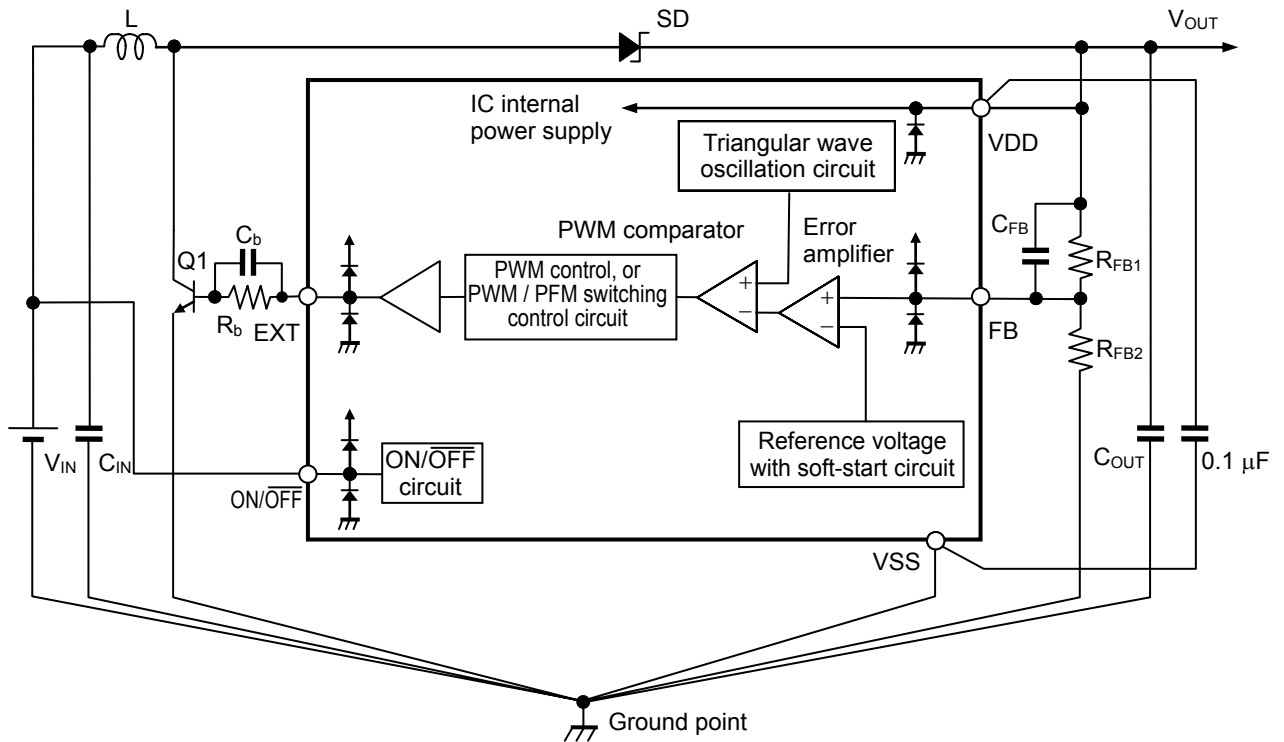

Figure 22

Caution The above connection diagram and constant will not guarantee successful operation. Perform thorough evaluation using an actual application to set the constants.

■ **Precaution**

- Mount external capacitors and inductor as close as possible to the IC. Set single point ground.
- Characteristics ripple voltage and spike noise occur in IC containing switching regulators. Moreover rush current flows at the time of a power supply injection. Because these largely depend on the inductor, the capacitor and impedance of power supply used, fully check them using an actually mounted model.
- The 0.1 μF capacitor connected between the VDD and VSS pins is a bypass capacitor. It stabilizes the power supply in the IC when application is used with a heavy load, and thus effectively works for stable switching regulator operation. Allocate the bypass capacitor as close to the IC as possible, prioritized over other parts.
- Although the IC contains a static electricity protection circuit, static electricity or voltage that exceeds the limit of the protection circuit should not be applied.
- The power dissipation of the IC greatly varies depending on the size and material of the board to be connected. Perform sufficient evaluation using an actual application before designing.
- SII claims no responsibility for any disputes arising out of or in connection with any infringement by products including this IC of patents owned by a third party.

■ Application Circuits

Application circuits are examples. They may always not guarantee successful operation.

1. External parts for application circuits

Table 16 Characteristics of External Parts

Part	Part Name	Manufacturer	Characteristics
Inductor	NR6028T-2R2M	Taiyo Yuden Co., Ltd.	2.2 μ H, DCR ^{*1} = 0.020 Ω , I _{MAX} ^{*2} = 4.2 A, L × W × H = 6.0 × 6.0 × 2.8 mm
	LTF5022T-3R3M	TDK Corporation	3.3 μ H, DCR ^{*1} = 0.060 Ω , I _{MAX} ^{*2} = 2.7 A, L × W × H = 5.0 × 5.2 × 2.2 mm
	VLF3010ST-2R2M		2.2 μ H, DCR ^{*1} = 0.114 Ω , I _{MAX} ^{*2} = 1.1 A, L × W × H = 3.0 × 3.0 × 1.0 mm
	VLF3010ST-3R3M		3.3 μ H, DCR ^{*1} = 0.168 Ω , I _{MAX} ^{*2} = 0.87 A, L × W × H = 3.0 × 3.0 × 1.0 mm
Diode	RB070M-30TR	Rohm Co., Ltd.	V _F ^{*3} = 0.44 V, I _F ^{*4} = 1.5 A, V _R ^{*5} = 30 V L × W × H = 3.5 × 1.6 × 0.9 mm
	RB050LA-30		V _F ^{*3} = 0.45 V, I _F ^{*4} = 3.0 A, V _R ^{*5} = 30 V L × W × H = 4.7 × 2.6 × 1.05 mm
Transistor	Si2312BDS	VISHAY INTERTECHNOLOGY, INC.	V _{DSS} ^{*6} = 20 V, V _{GSS} ^{*7} = ±8 V, I _D ^{*8} = 5.0 A, Q _G ^{*9} = 12 nC max. R _{DS(ON)} ^{*10} = 0.047 Ω max. (V _{GS} ^{*11} = 2.5 V) L × W × H = 2.9 × 2.64 × 1.12 mm
	2SD2652	Rohm Co., Ltd.	V _{CEO} ^{*12} = 12 V, V _{EBO} ^{*13} = 6 V, I _C ^{*14} = 1.5 A, h _{FE} ^{*15} = 270 min./680 max. (V _{CE/IC} = 2 V/200 mA) L × W × H = 2.0 × 1.25 × 0.9 mm
Capacitor	JMK107BJ106MA-T	Taiyo Yuden Co., Ltd.	10 μ F, E _{DC} ^{*16} = 6.3 V, X5R, L × W × H = 1.6 × 0.8 × 0.95 mm
	LMK212BJ106KD-T		10 μ F, E _{DC} ^{*16} = 10 V, X5R, L × W × H = 2.0 × 1.25 × 0.95 mm
	EMK316BJ106KF-T		10 μ F, E _{DC} ^{*16} = 16 V, X5R, L × W × H = 3.2 × 1.6 × 1.25 mm
	TMK325B7106MN-T	TDK Corporation	10 μ F, E _{DC} ^{*16} = 25 V, X7R, L × W × H = 3.2 × 2.5 × 2.1 mm
	C2012X5R1A106KT		10 μ F, E _{DC} ^{*16} = 10 V, X5R, L × W × H = 2.0 × 1.25 × 1.45 mm
	C1005X7R1C104KT		0.1 μ F, E _{DC} ^{*16} = 16 V, X7R, L × W × H = 1.0 × 0.5 × 0.55 mm
	GRM31CR71A106KA	Murata Manufacturing, Co., Ltd.	10 μ F, E _{DC} ^{*16} = 10 V, X7R, L × W × H = 3.2 × 1.6 × 1.6 mm

- * 1. DCR : DC resistance
- * 2. I_{MAX} : Maximum allowable current
- * 3. V_F : Forward voltage
- * 4. I_F : Forward current
- * 5. V_R : Reverse voltage
- * 6. V_{DSS} : Drain-source voltage (during short-circuiting between the gate and source)
- * 7. V_{GSS} : Gate-source voltage (during short-circuiting between the drain and source)
- * 8. I_D : Drain current
- * 9. Q_G : Gate charge
- * 10. R_{DS(ON)} : On-resistance between the drain and source
- * 11. V_{GS} : Gate-source voltage
- * 12. V_{CEO} : Collector-emitter voltage
- * 13. V_{EBO} : Emitter-base voltage
- * 14. I_C : Collector current
- * 15. h_{FE} : Direct current gain
- * 16. E_{DC} : Rated voltage

2. Power supply for LCD

Following shows a circuit example and its characteristics for driving an LCD panel (with 9 V and 15 V outputs).

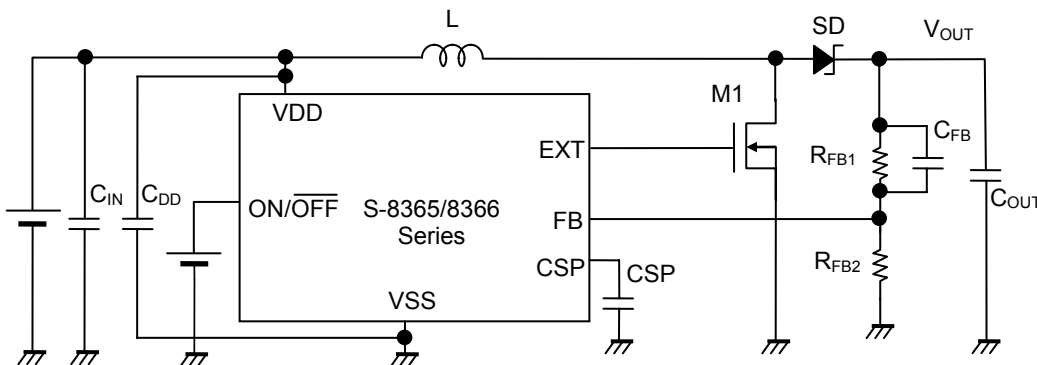

Figure 23 Circuit Example (Power Supply for LCD)

Table 17 External Part Examples (Power Supply for LCD) (1 / 2)

Condition	Output Voltage	IC Product Name	L Product Name	M1 Product Name	SD Product Name
1	9 V	S-8365AABBA	NR6028T2R2M	Si2312BDS	RB050LA-30
2	9 V	S-8366AABBA	NR6028T2R2M	Si2312BDS	RB050LA-30
3	15 V	S-8365AABBA	NR6028T2R2M	Si2312BDS	RB050LA-30
4	15 V	S-8366AABBA	NR6028T2R2M	Si2312BDS	RB050LA-30

Table 17 External Part Examples (Power Supply for LCD) (2 / 2)

Condition	C _{IN} Product Name	C _{OUT} Product Name	R _{FB1}	R _{FB2}	C _{FB}	C _{DD}
1	LMK212BJ106KG-T	EMK316BJ106KF-T × 2	280 kΩ	20 kΩ	22 pF	0.1 μF
2	LMK212BJ106KG-T	EMK316BJ106KF-T × 1	280 kΩ	20 kΩ	27 pF	0.1 μF
3	LMK212BJ106KG-T	TMK325B7106MN-T × 2	360 kΩ	15 kΩ	27 pF	0.1 μF
4	LMK212BJ106KG-T	TMK325B7106MN-T × 1	360 kΩ	15 kΩ	33 pF	0.1 μF

Caution The above connection will not guarantee successful operation. Perform thorough evaluation using an actual application to set the constant.

3. Output Characteristics of Power Supply for LCD

Following shows the output current (I_{OUT}) vs. efficiency (η) and output current (I_{OUT}) vs. output voltage (V_{OUT}) characteristics for conditions 1 to 4 in **Table 17**.

Condition 1

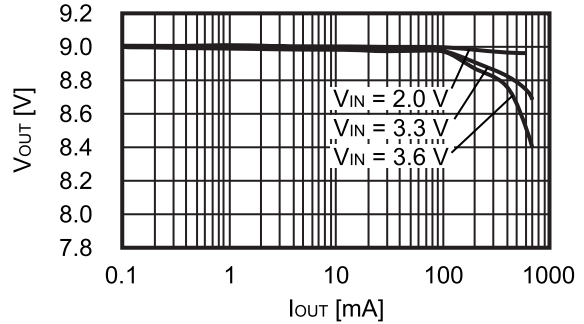
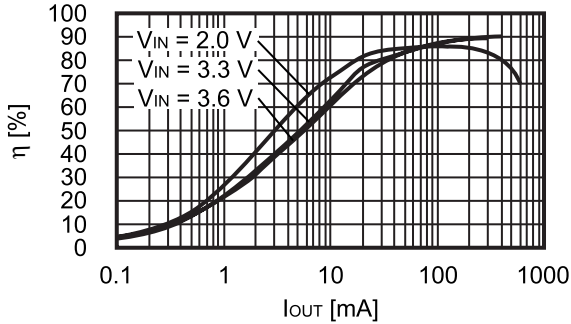

Condition 2

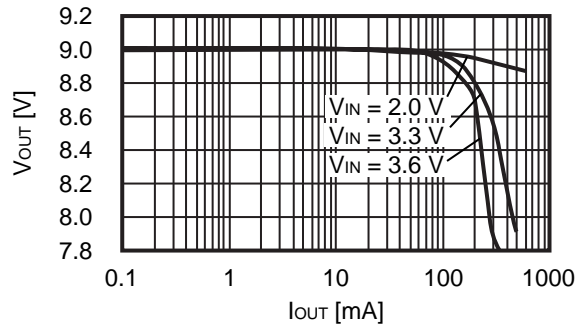
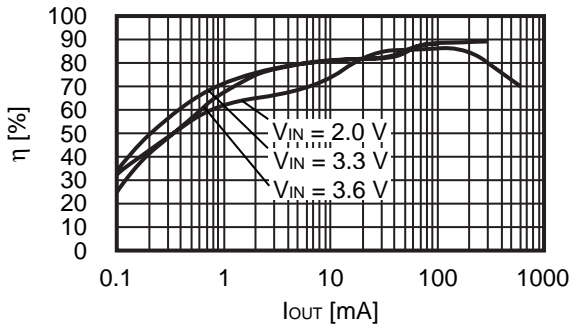

Condition 3

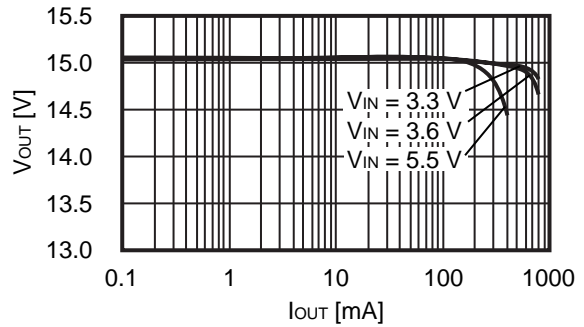
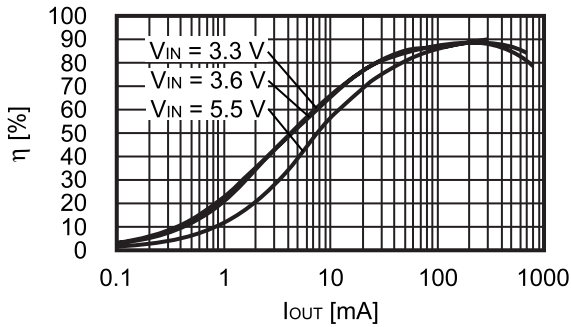

Condition 4

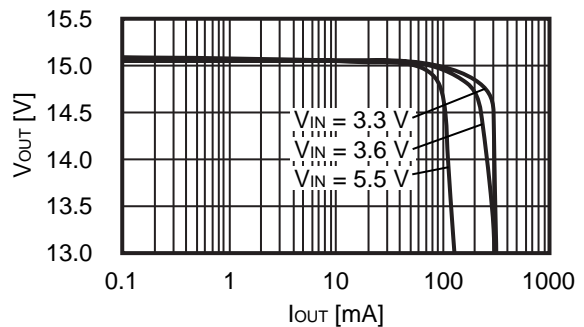
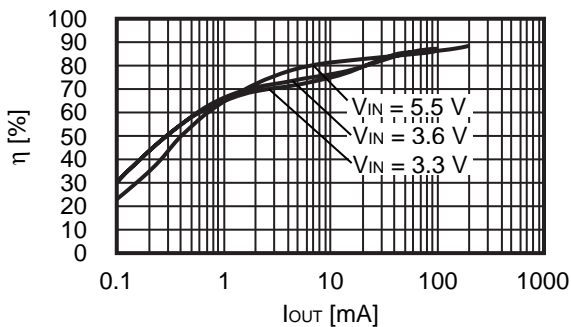

4. Power supply for high output current

Following shows a circuit example and its characteristics for outputting 3.3 V from two dry cells (1.8 V) and satisfying $I_{OUT} = 800$ mA.

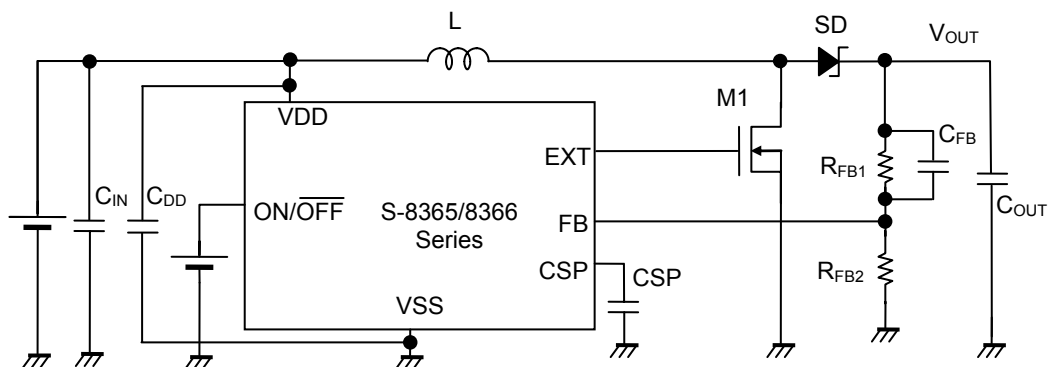

Figure 24 Circuit Example (Power Supply for High Output Current)

Table 18 External Part Examples (Power Supply for High Output Current) (1 / 2)

Condition	Output Voltage	IC Product Name	L Product Name	M1 Product Name	SD Product Name
1	3.32 V	S-8365AABBA	NR6028T2R2M	Si2312BDS	RB050LA-30
2	3.32 V	S-8365ABBBA	LTF5022-3R3M	Si2312BDS	RB050LA-30
3	3.32 V	S-8366AABBA	NR6028T2R2M	Si2312BDS	RB050LA-30
4	3.32 V	S-8366ABBBA	LTF5022-3R3M	Si2312BDS	RB050LA-30

Table 18 External Part Examples (Power Supply for High Output Current) (2 / 2)

Condition	C _{IN} Product Name	C _{OUT} Product Name	R _{FB1}	R _{FB2}	C _{FB}	C _{DD}
1	C2012X5R1A106KT	GRM31CR71A106KA × 2	68 kΩ	15 kΩ	68 pF	0.1 μF
2	C2012X5R1A106KT	GRM31CR71A106KA × 2	68 kΩ	15 kΩ	82 pF	0.1 μF
3	C2012X5R1A106KT	GRM31CR71A106KA × 2	68 kΩ	15 kΩ	68 pF	0.1 μF
4	C2012X5R1A106KT	GRM31CR71A106KA × 2	68 kΩ	15 kΩ	82 pF	0.1 μF

Caution The above connection will not guarantee successful operation. Perform thorough evaluation using an actual application to set the constant.

5. Output characteristics of power supply for high output current

Following shows the output current (I_{OUT}) vs. efficiency (η) and output current (I_{OUT}) vs. output voltage (V_{OUT}) characteristics for conditions 1 to 4 in **Table 18**.

Condition 1

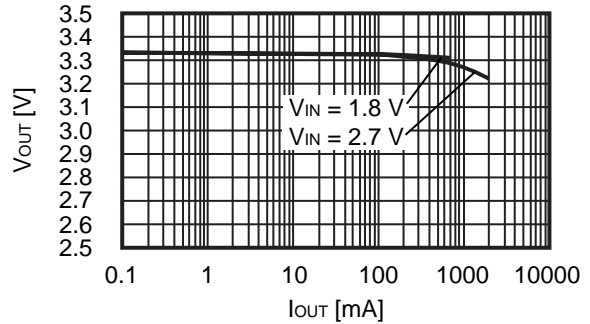
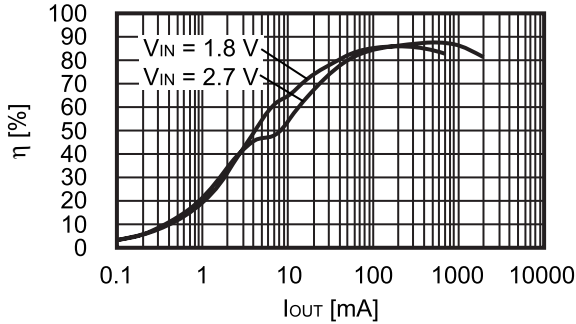

Condition 2

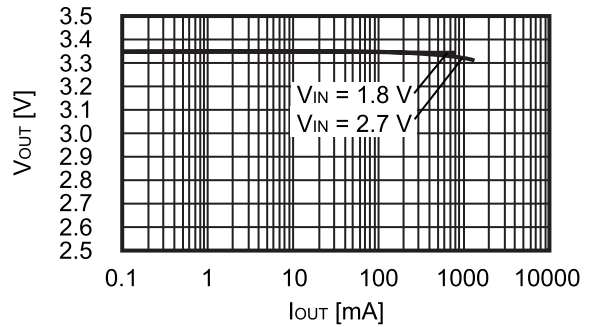
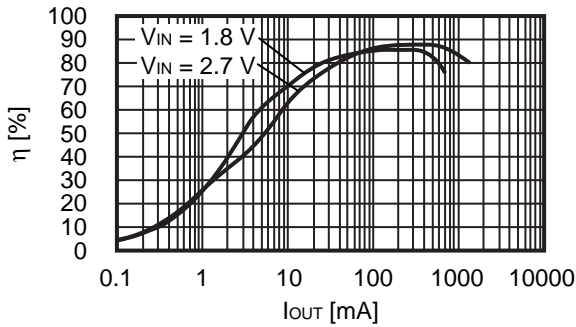

Condition 3

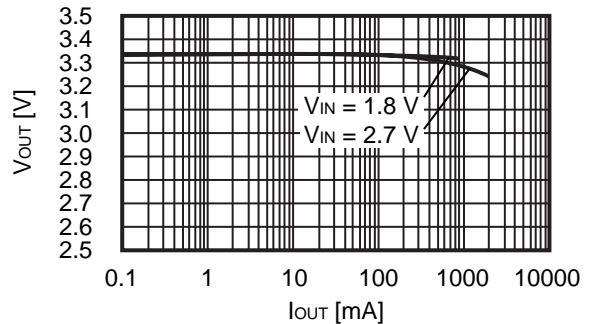
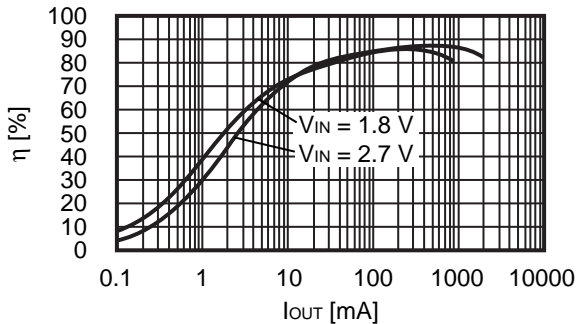

Condition 4

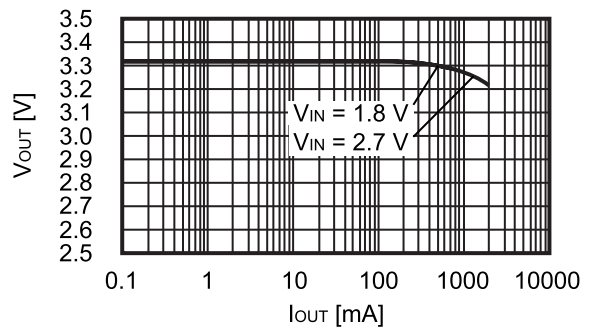
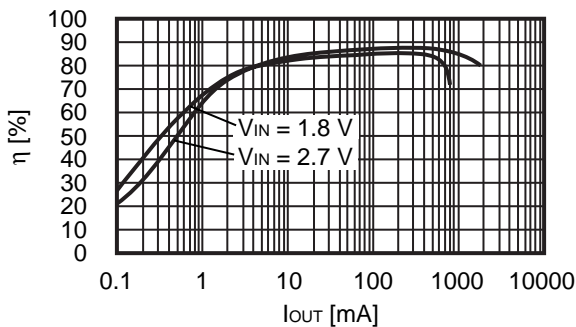

6. Circuit for low power supply voltage applications

Following shows a circuit example that starts up by using a dry cell (1.2 V) and its characteristics.

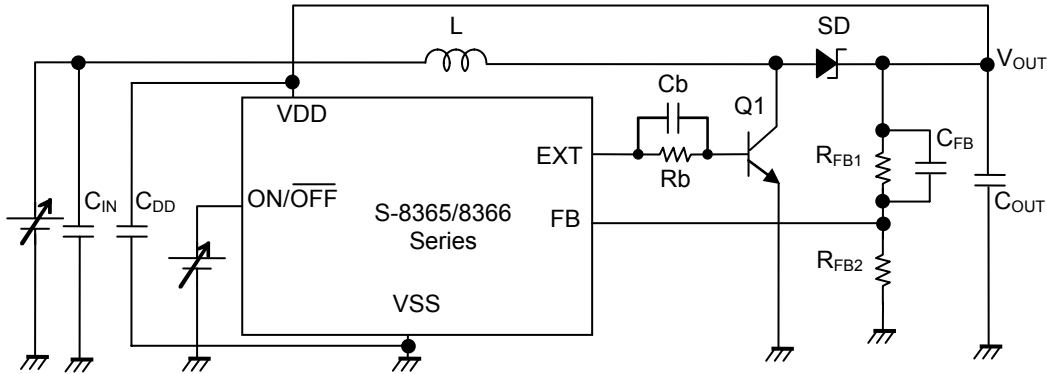

Figure 25 Circuit Example (Circuit for Low Power Supply Voltage Applications)

Table 19 External Part Examples (Circuit for Low Power Supply Voltage Applications) (1 / 2)

Condition	Output Voltage	IC Product Name	L Product Name	Q1 Product Name	SD Product Name
1	3.32 V	S-8366AAAAA	VLF3010ST-2R2M	2SD2652	RB070M-30TR
2	3.32 V	S-8366ABAAA	VLF3010ST-3R3M	2SD2652	RB070M-30TR

Table 19 External Part Examples (Circuit for Low Power Supply Voltage Applications) (2 / 2)

Condition	C _{IN} Product Name	C _{OUT} Product Name	R _{FB1}	R _{FB2}	C _{FB}	C _{DD}
1	JMK107BJ106MA-T	LMK212BJ106KD-T × 1	68 kΩ	15 kΩ	68 pF	0.1 μF
2	JMK107BJ106MA-T	LMK212BJ106KD-T × 1	68 kΩ	15 kΩ	82 pF	0.1 μF

Caution The above connection will not guarantee successful operation. Perform thorough evaluation using an actual application to set the constant.

7. Output characteristics of circuits for low power supply voltage applications

Following shows the output current (I_{OUT}) vs. efficiency (η) and output current (I_{OUT}) vs. output voltage (V_{OUT}) characteristics for conditions 1 and 2 in **Table 19**.

Condition 1

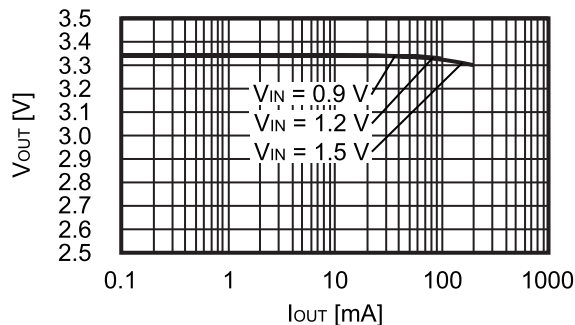
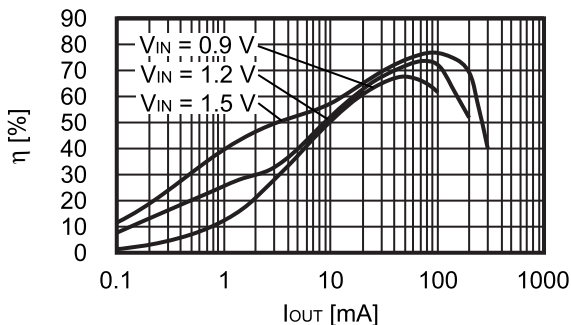

Condition 2

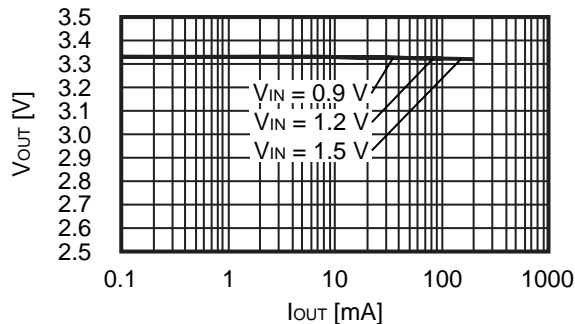
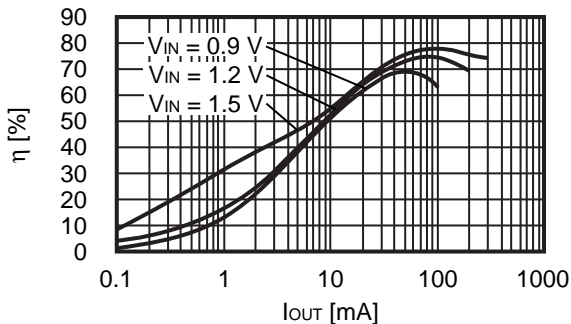

■ Characteristics (Typical Data)

1. Examples of Major Power Supply Dependence Characteristics (Ta = 25°C)

(1) Current consumption during operation (I_{SS1}) vs. Input voltage (V_{IN})

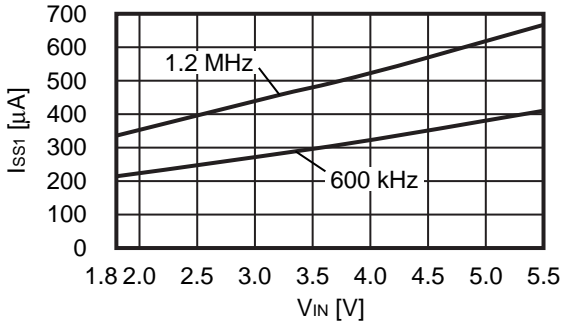

(2) Current consumption during shutdown (I_{SSS}) vs. Input voltage (V_{IN})

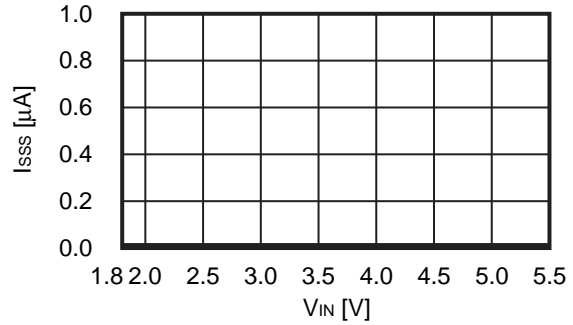

(3) Oscillation frequency (f_{osc}) vs. Input voltage (V_{IN})

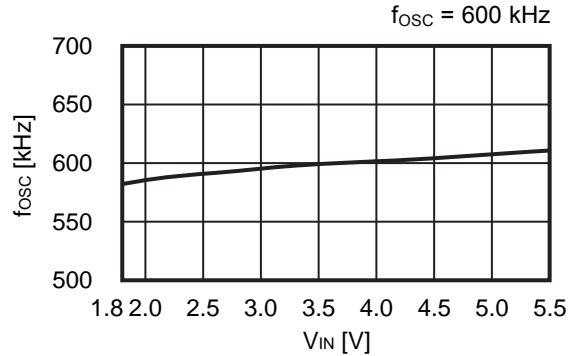
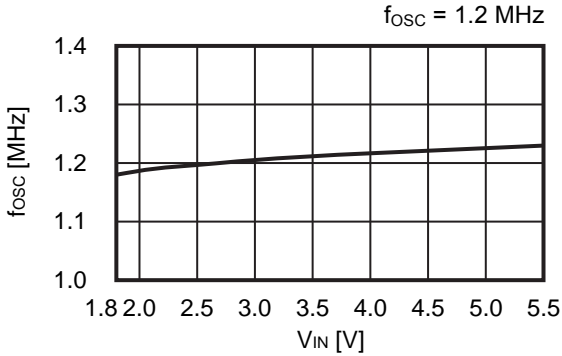

(4) Maximum duty ratio (MaxDuty) vs. Input voltage (V_{IN})

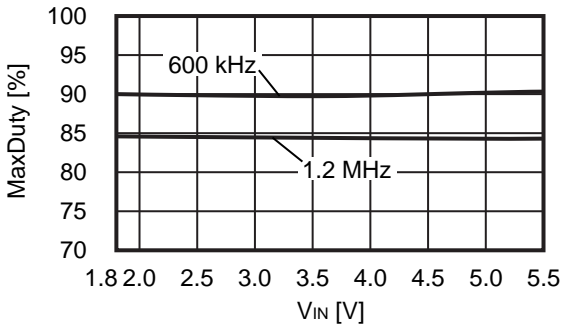

(5) Soft-start time (t_{SS}) vs. Input voltage (V_{IN})

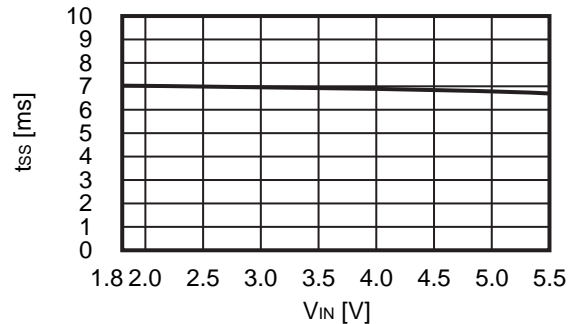

(6) PWM / PFM switching duty ratio (PFMDuty) vs. Input voltage (V_{IN})

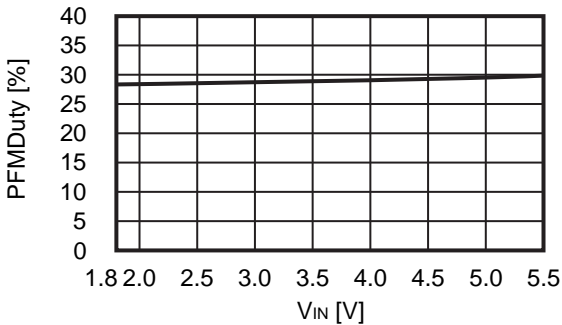

(7) High level input voltage (V_{SH}) vs. Input voltage (V_{IN})

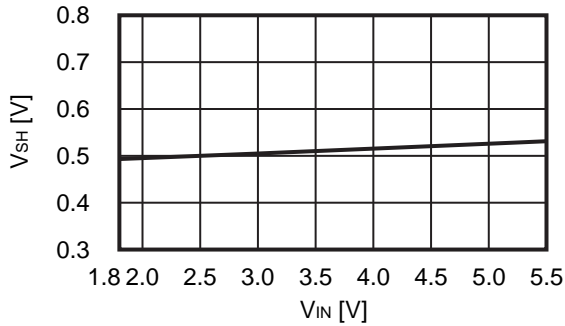

(8) Low level input voltage (V_{SL}) vs. Input voltage (V_{IN})

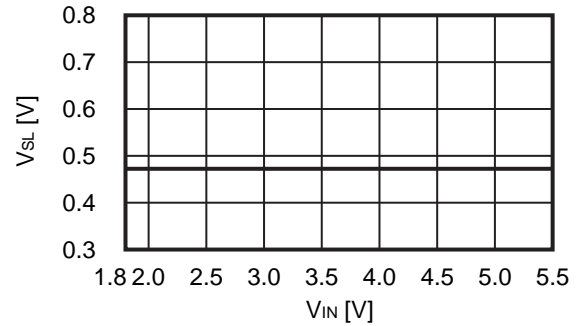

(9) FB voltage (V_{FB}) vs. Input voltage (V_{IN})

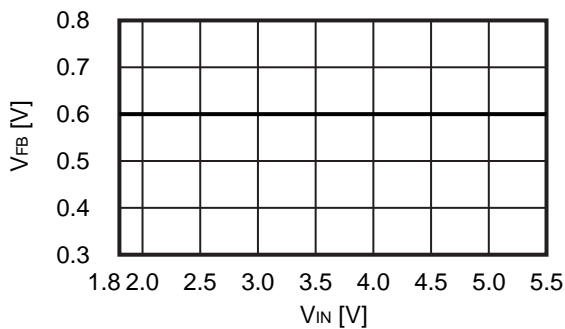

(10) Short-circuit protection delay time (t_{PRO}) vs. Input voltage (V_{IN})

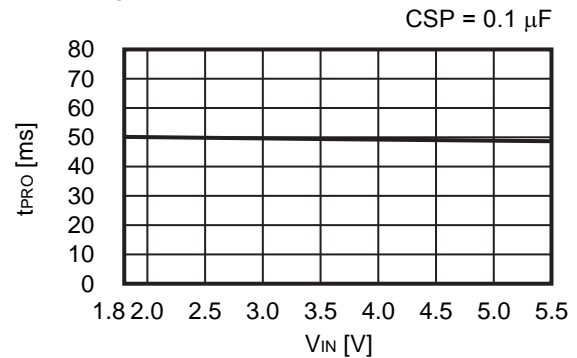

(11) EXT pin output current "H" (I_{EXTH}) vs. Input voltage (V_{IN})

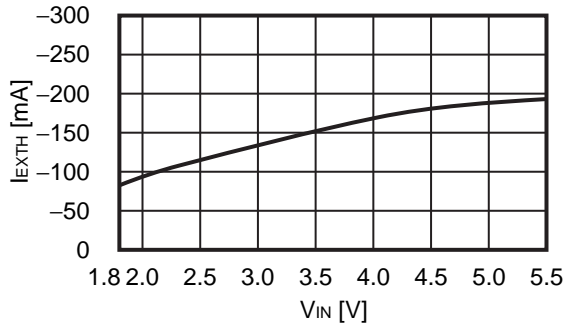

(12) EXT pin output current "L" (I_{EXTL}) vs. Input voltage (V_{IN})

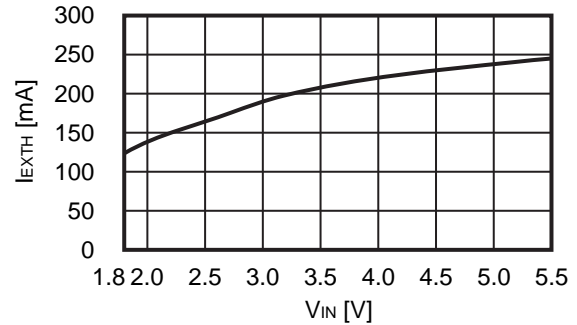

2. Examples of Major Temperature Characteristics (Ta = -40 to 85°C)

(1) Current consumption during operation (Iss1) vs. Temperature (Ta)

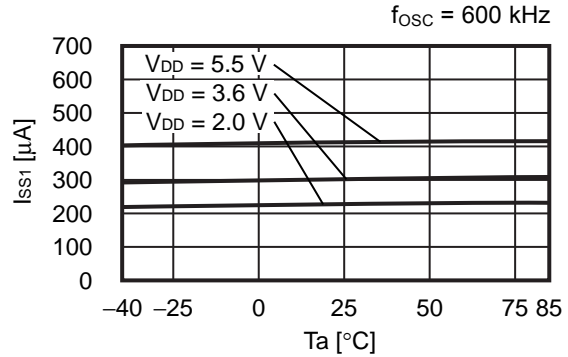
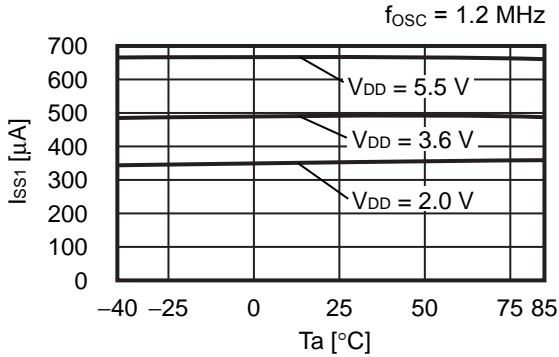

(2) Current consumption during shutdown (Isss) vs. Temperature (Ta)

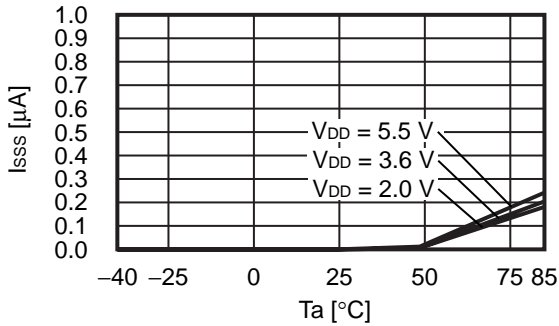

(3) Oscillation frequency (fosc) vs. Temperature (Ta)

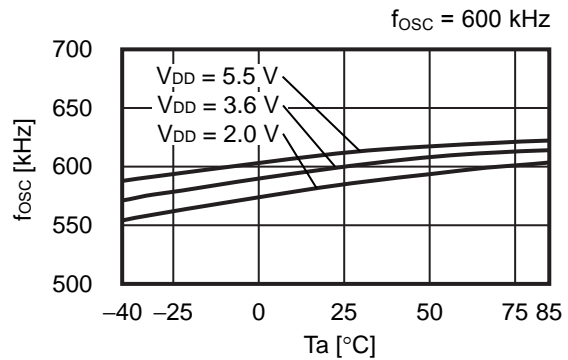
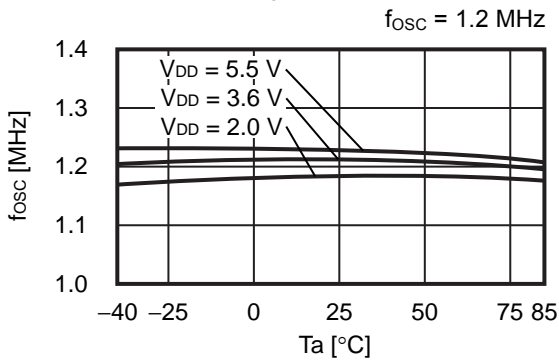

(4) Maximum duty ratio (MaxDuty) vs. Temperature (Ta)

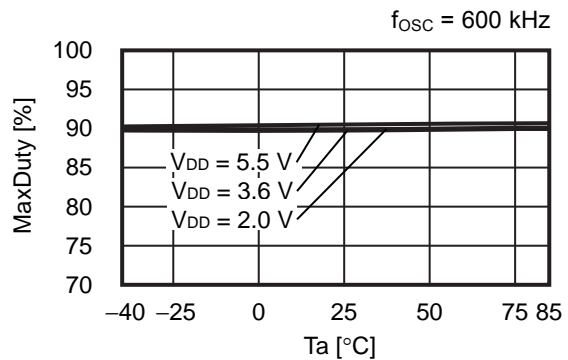
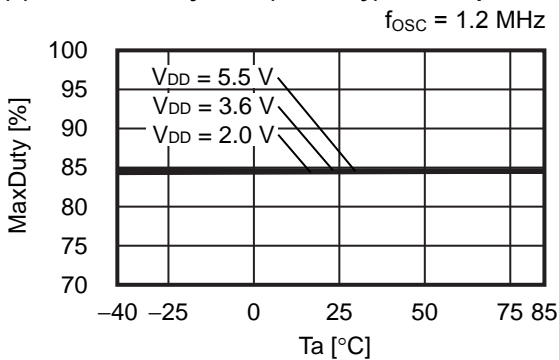

(5) Soft-start time (t_{SS}) vs. Temperature (T_a)

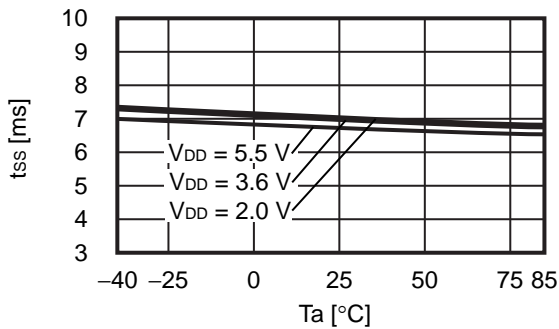

(6) PWM / PFM switching duty ratio (PFMDuty) vs. Temperature (T_a)

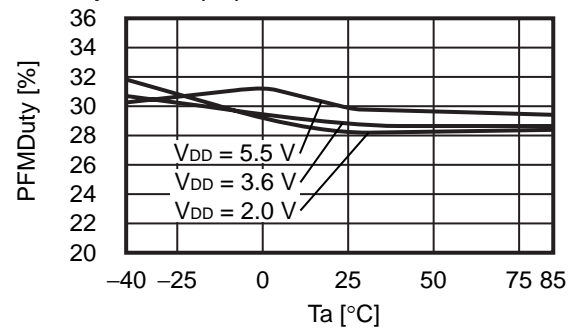

(7) High level input voltage (V_{SH}) vs. Temperature (T_a)

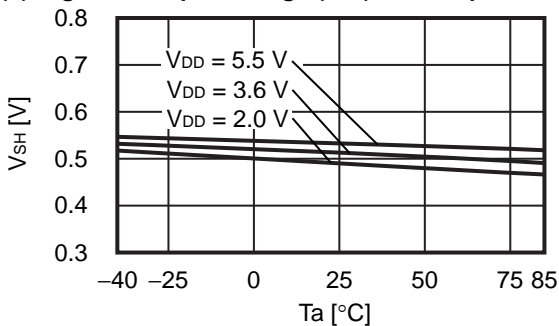

(8) Low level input voltage (V_{SL}) vs. Temperature (T_a)

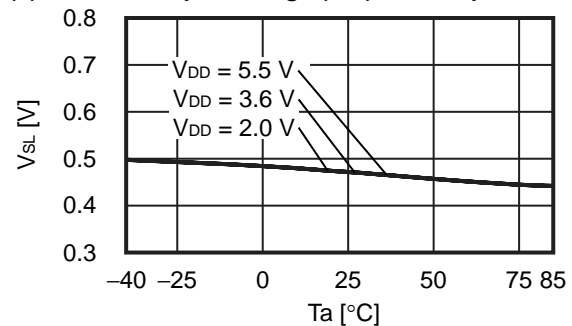

(9) UVLO release voltage (V_{UVLO+}) vs. Temperature (T_a)

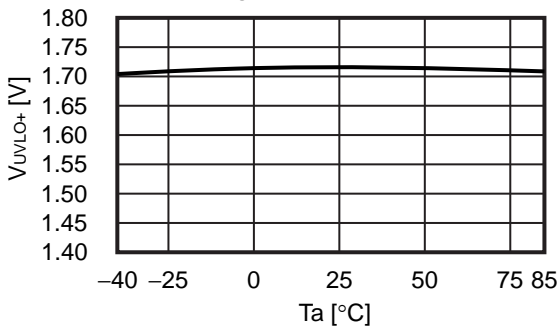

(10) UVLO hysteresis width ($V_{UVLOHYS}$) vs. Temperature (T_a)

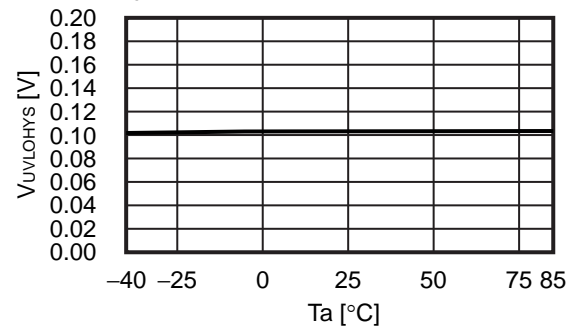

(11) FB voltage (V_{FB}) vs. Temperature (T_a)

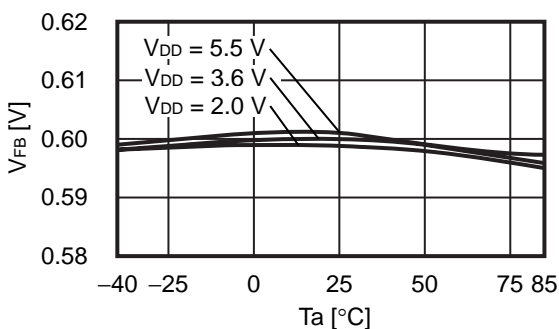

(12) Short-circuit protection delay time (t_{PRO}) vs. Temperature (T_a)

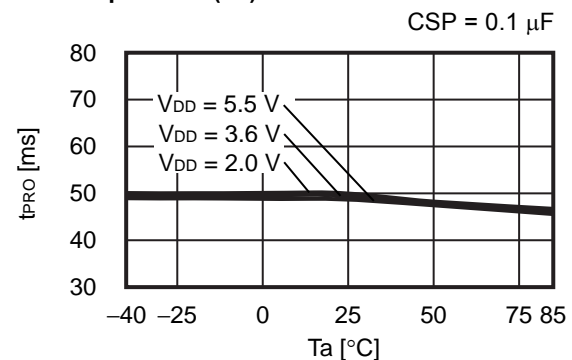

(13) EXT pin output current "H" (I_{EXTH}) vs. Temperature (T_a)

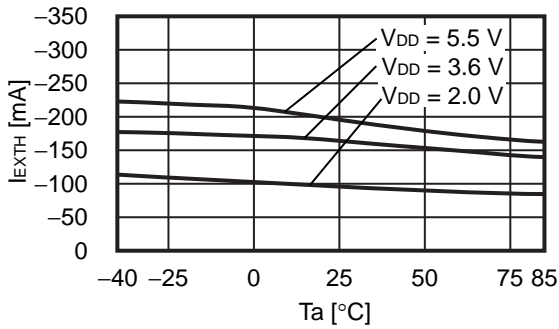

(14) EXT pin output current "L" (I_{EXTL}) vs. Temperature (T_a)

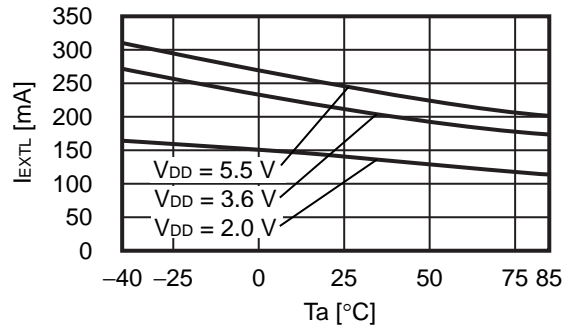

(15) Operating start voltage (V_{ST1}) vs. Temperature (T_a)

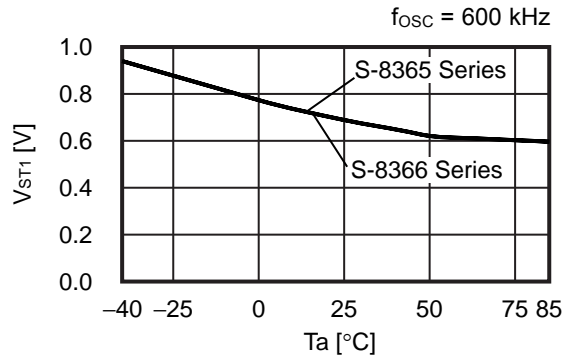
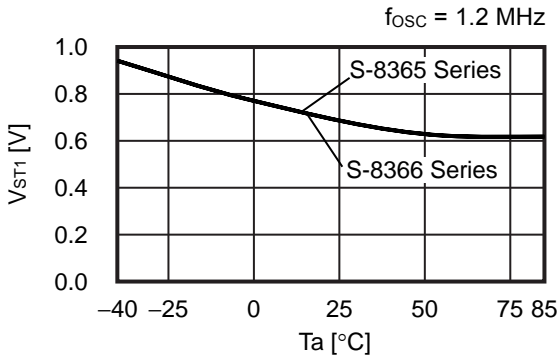

(16) Oscillation start voltage (V_{ST2}) vs. Temperature (T_a)

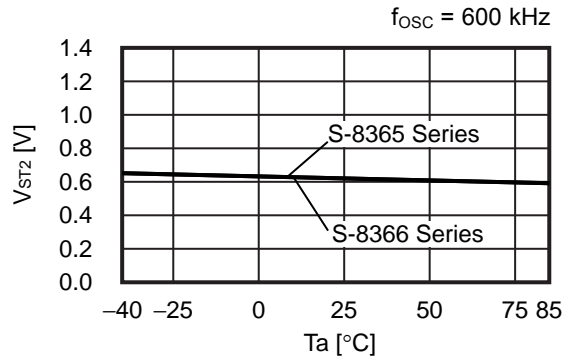
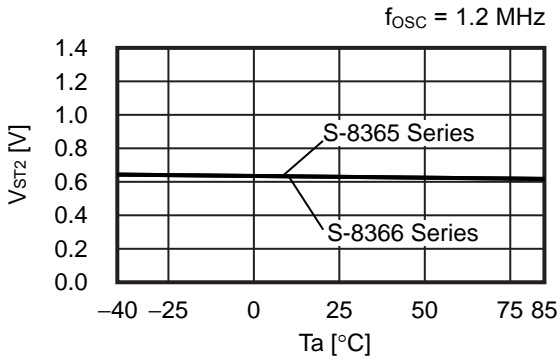

(17) Operation holding voltage (V_{HLD}) vs. Temperature (T_a)

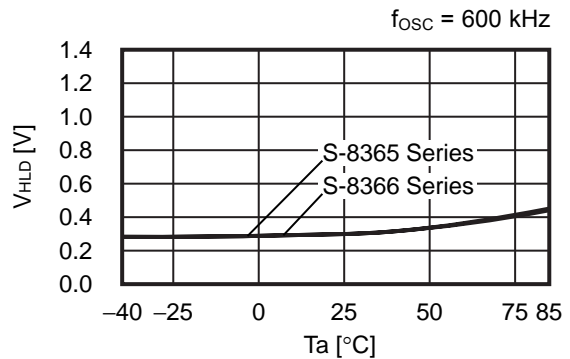
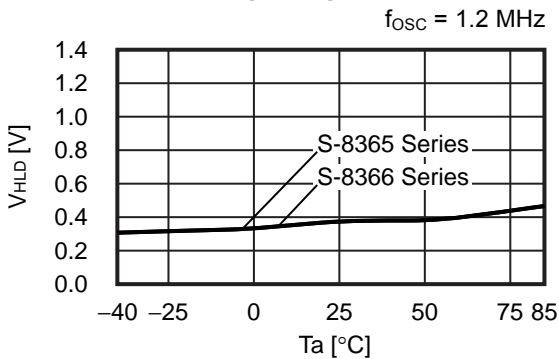

3. Examples of Transient Response Characteristics

Unless otherwise specified, the used parts are those in **Table 10 External Parts List**.

3.1 At power-on ($V_{OUT(S)} = 5.0\text{ V}$, $V_{IN} = 0\text{ V} \rightarrow 3.3\text{ V}$, PWM control, $T_a = 25^\circ\text{C}$)

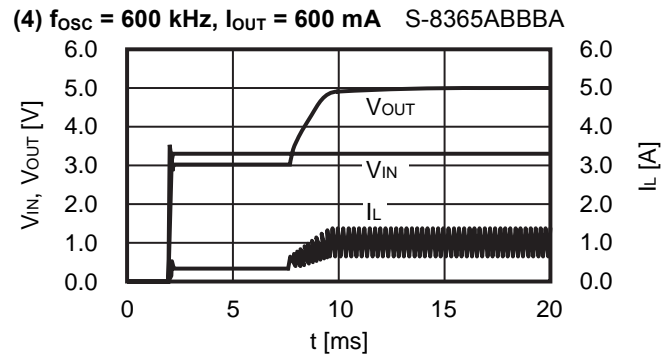
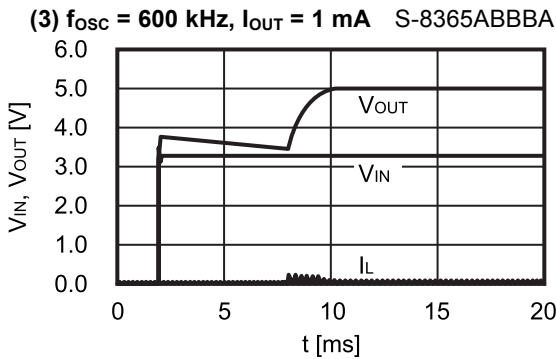
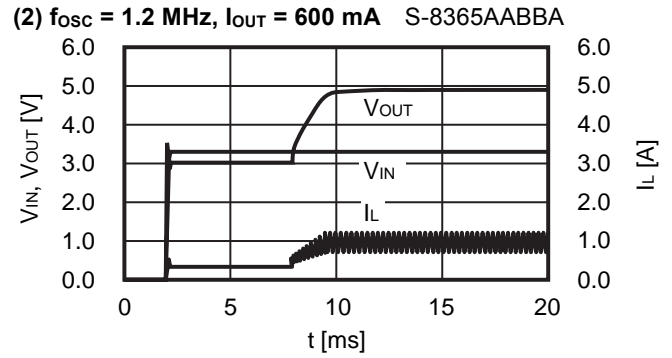
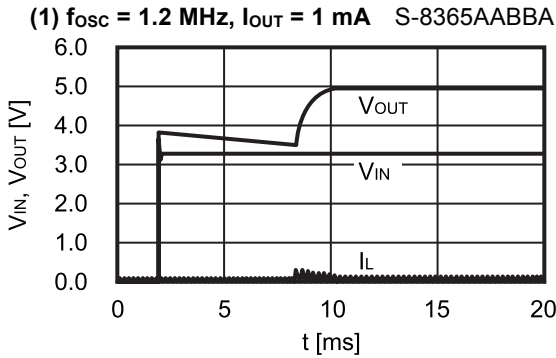

3.2 At power-on ($V_{OUT(S)} = 5.0\text{ V}$, $V_{IN} = 0\text{ V} \rightarrow 3.3\text{ V}$, PWM / PFM switching control, $T_a = 25^\circ\text{C}$)

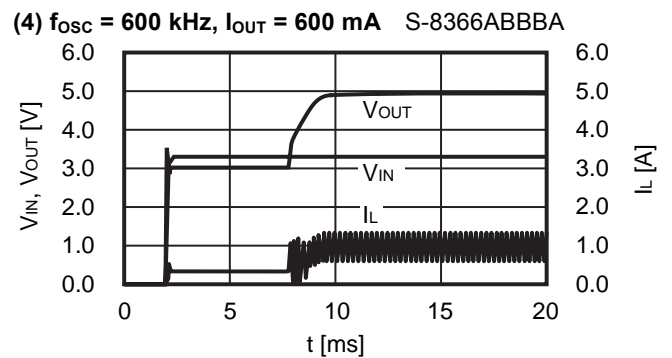
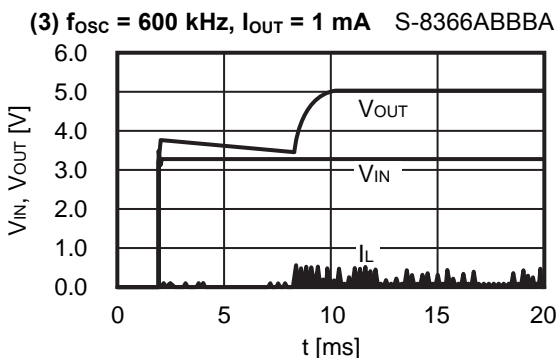
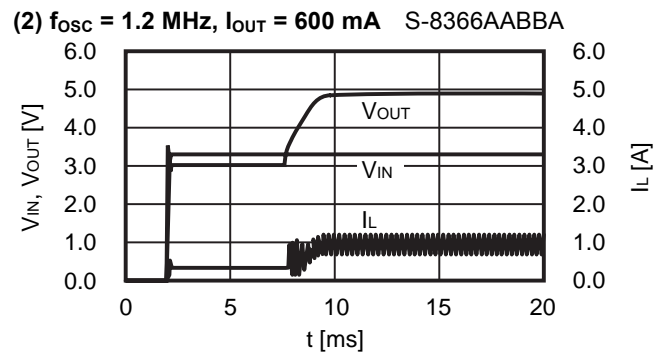
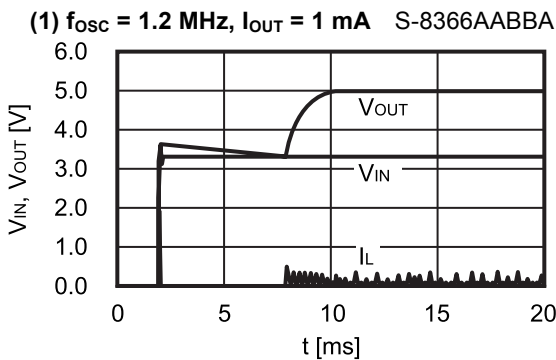

3.3 Shutdown pin response ($V_{OUT} = 5.0\text{ V}$, $V_{IN} = 3.3\text{ V}$, $V_{ON/OFF} = 0\text{ V} \rightarrow 3.3\text{ V}$, PWM control, $T_a = 25^\circ\text{C}$)

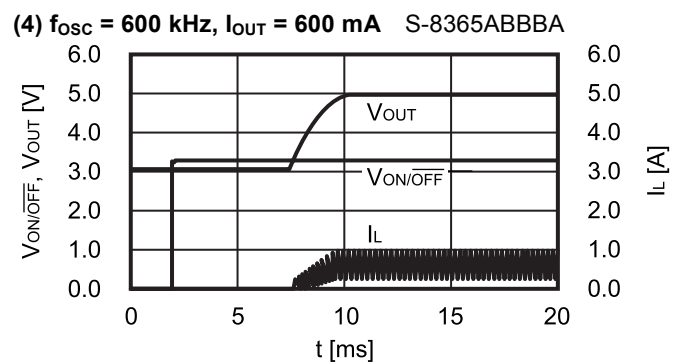
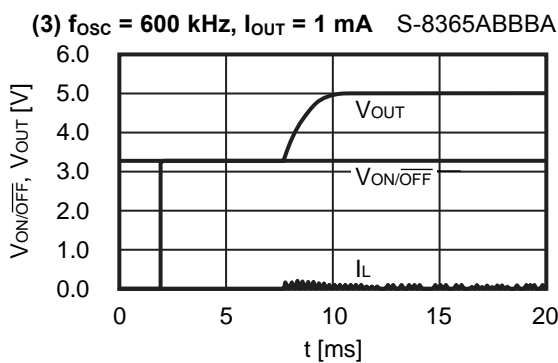
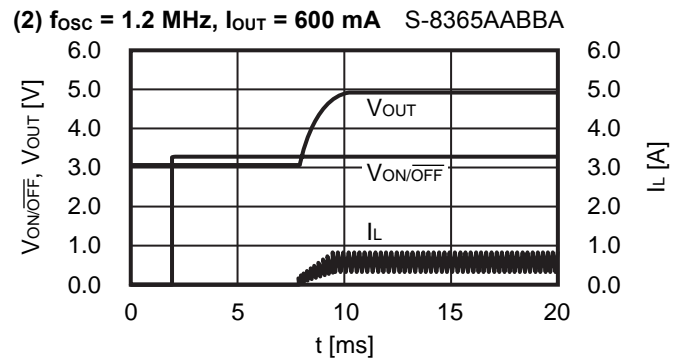
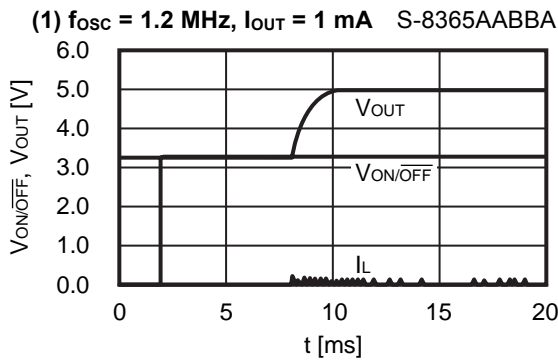

3.4 Shutdown pin response ($V_{OUT} = 5.0\text{ V}$, $V_{IN} = 3.3\text{ V}$, $V_{ON/OFF} = 0\text{ V} \rightarrow 3.3\text{ V}$, PWM / PFM switching control, $T_a = 25^\circ\text{C}$)

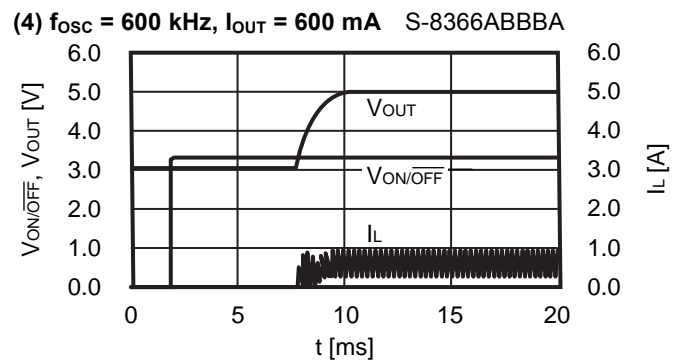
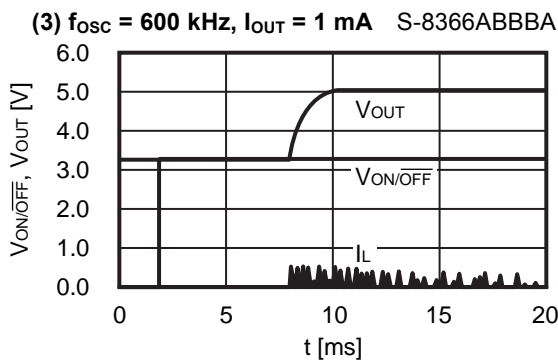
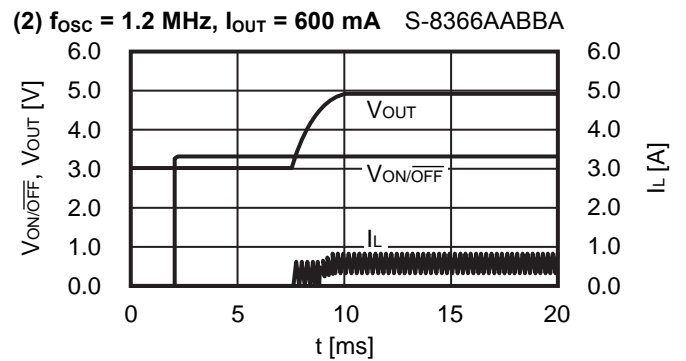
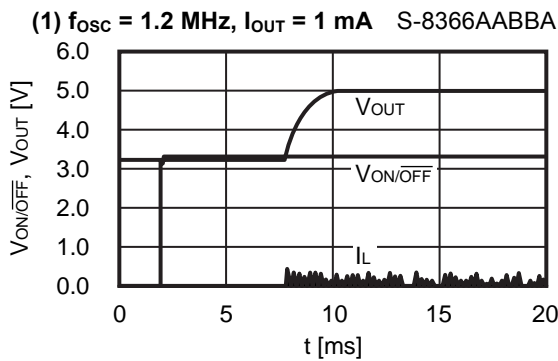

3.5 Power supply voltage fluctuations ($V_{OUT} = 5.0\text{ V}$, $I_{OUT} = 1\text{ mA}$, PWM control, $T_a = 25^\circ\text{C}$)

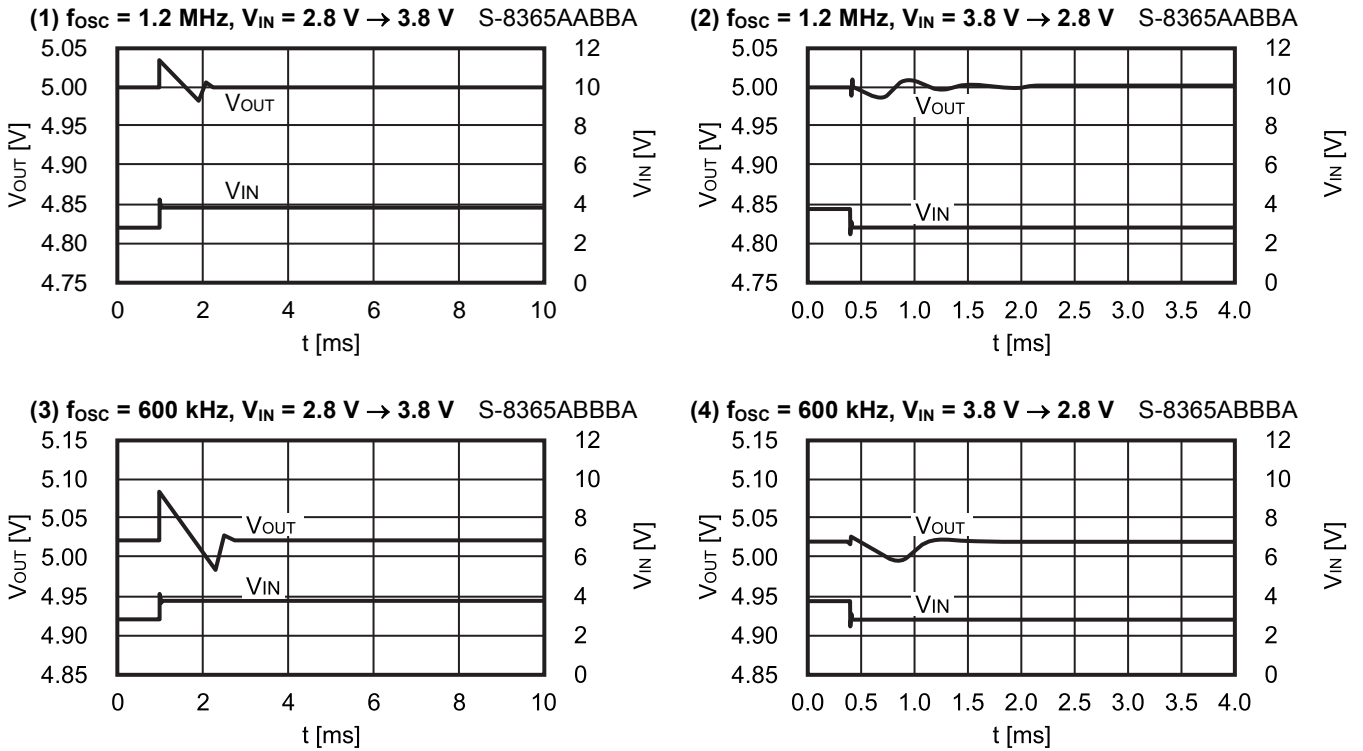

3.6 Power supply voltage fluctuations ($V_{OUT} = 5.0\text{ V}$, $I_{OUT} = 1\text{ mA}$, PWM / PFM switching control, $T_a = 25^\circ\text{C}$)

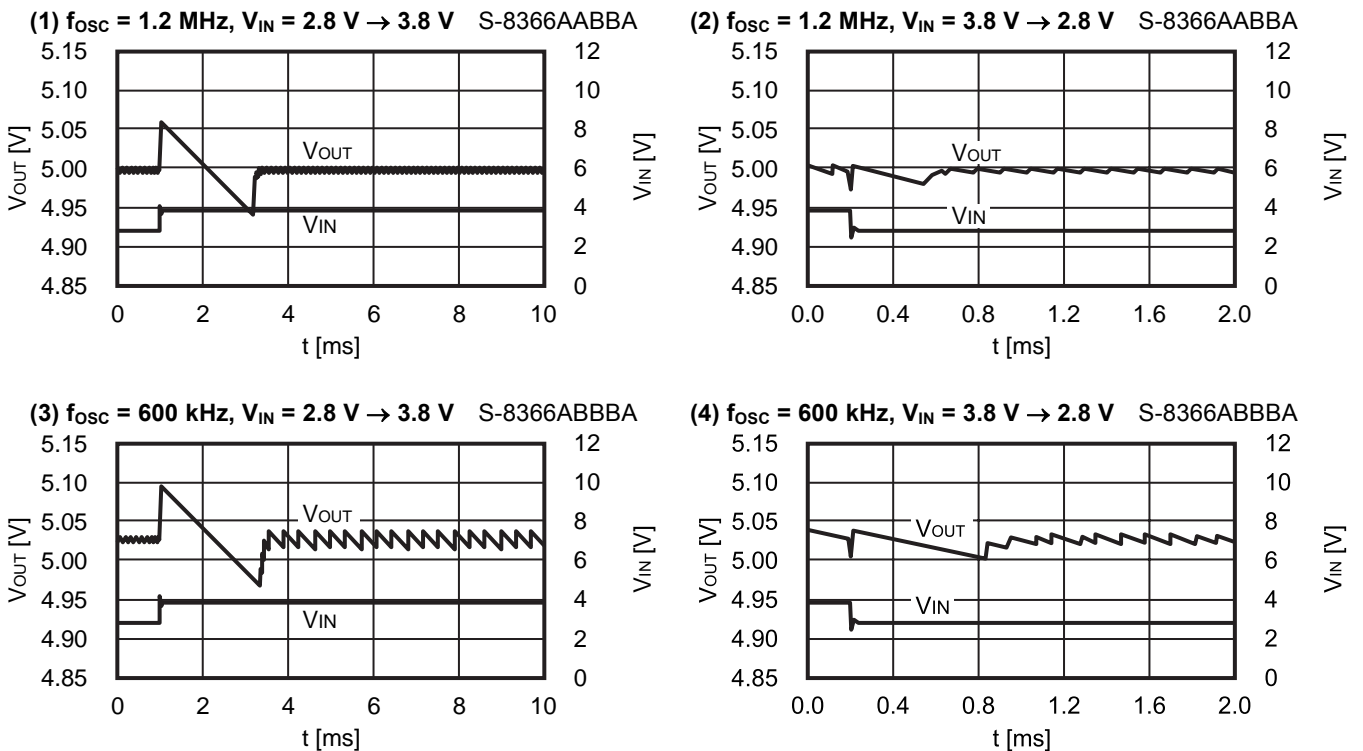

3.7 Power supply voltage fluctuations ($V_{OUT} = 5.0\text{ V}$, $I_{OUT} = 500\text{ mA}$, PWM control, $T_a = 25^\circ\text{C}$)

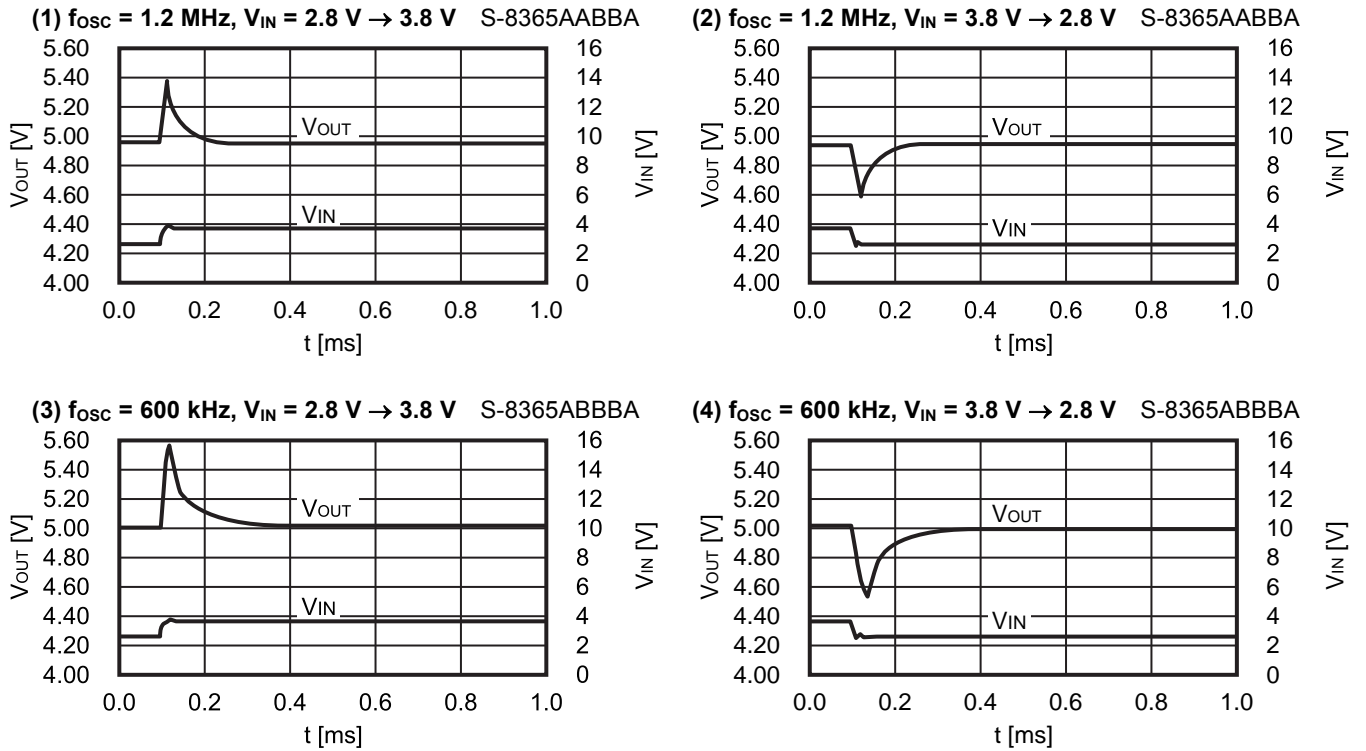

3.8 Power supply voltage fluctuations ($V_{OUT} = 5.0\text{ V}$, $I_{OUT} = 500\text{ mA}$, PWM / PFM switching control, $T_a = 25^\circ\text{C}$)

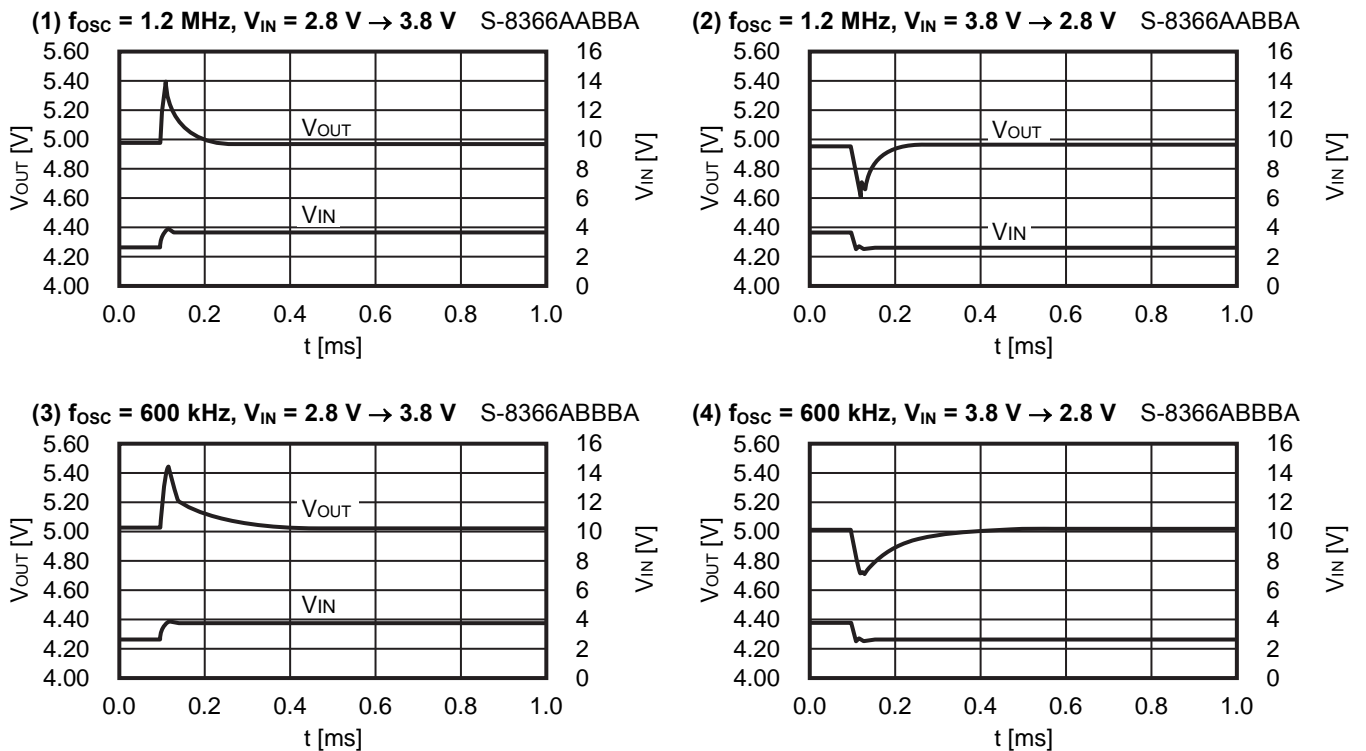

3.9 Load fluctuations ($V_{OUT} = 5.0\text{ V}$, $V_{IN} = 3.3\text{ V}$, $I_{OUT} = 0.1\text{ mA} \rightarrow 100\text{ mA} \rightarrow 0.1\text{ mA}$, PWM control, $T_a = 25^\circ\text{C}$)

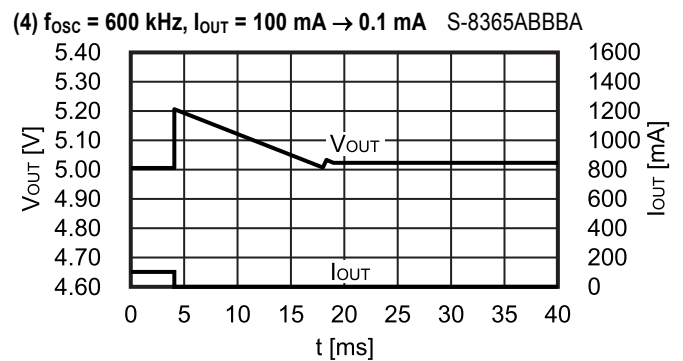
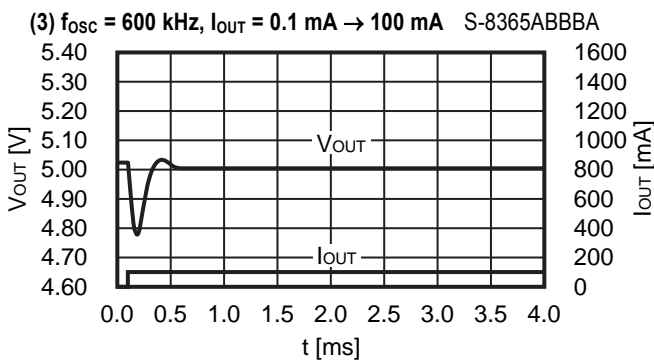
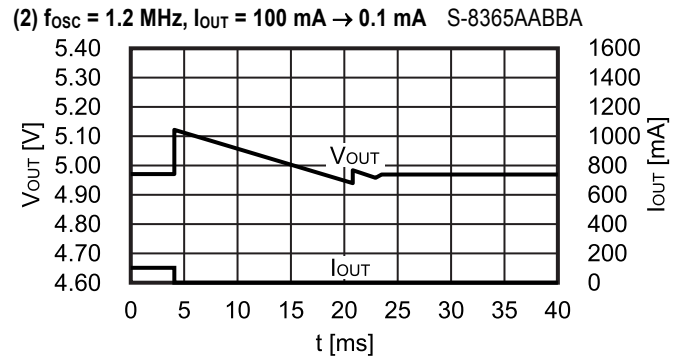
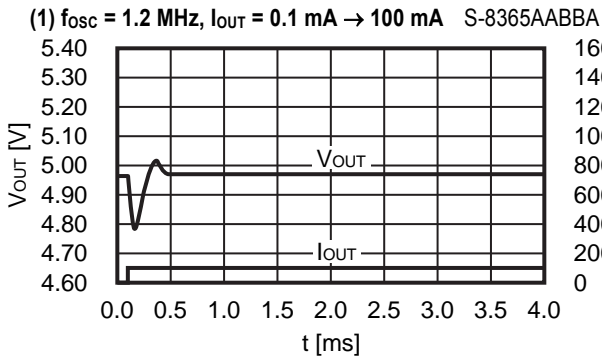

3.10 Load fluctuations ($V_{OUT} = 5.0\text{ V}$, $V_{IN} = 3.3\text{ V}$, $I_{OUT} = 0.1\text{ mA} \rightarrow 100\text{ mA} \rightarrow 0.1\text{ mA}$, PWM / PFM switching control, $T_a = 25^\circ\text{C}$)

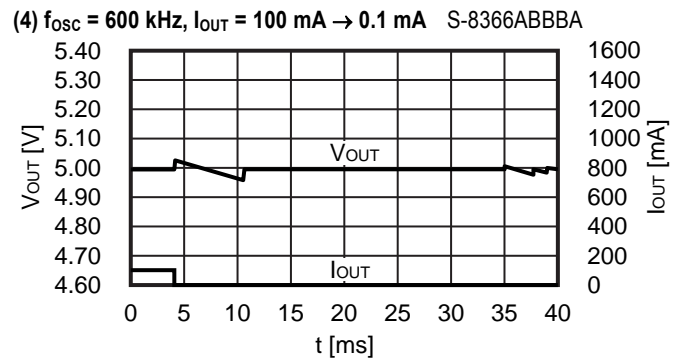
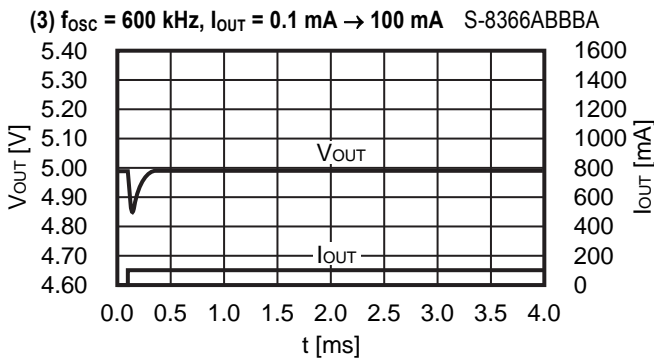
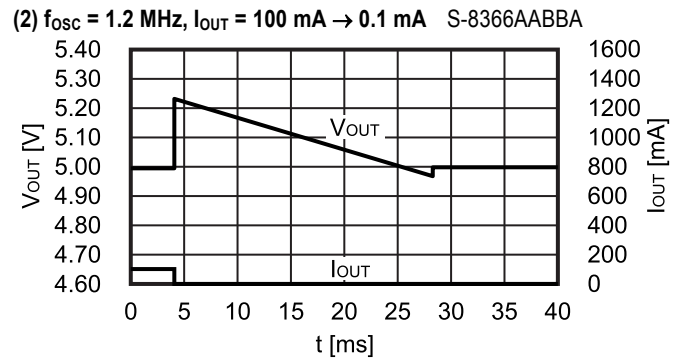
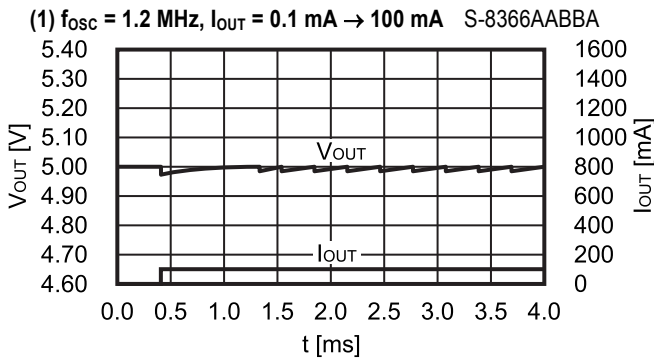

3.11 Load fluctuations ($V_{OUT} = 5.0\text{ V}$, $V_{IN} = 3.3\text{ V}$, $I_{OUT} = 0.1\text{ mA} \rightarrow 300\text{ mA} \rightarrow 0.1\text{ mA}$, PWM control, $T_a = 25^\circ\text{C}$)

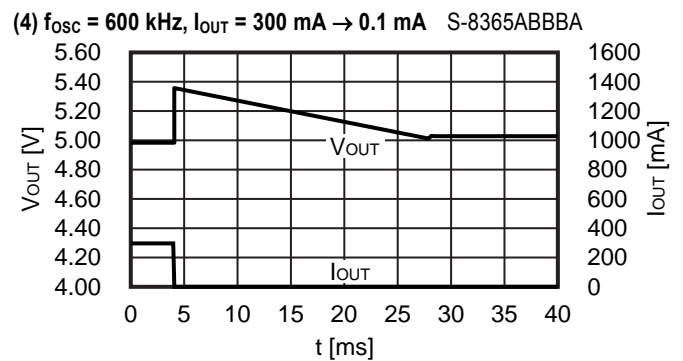
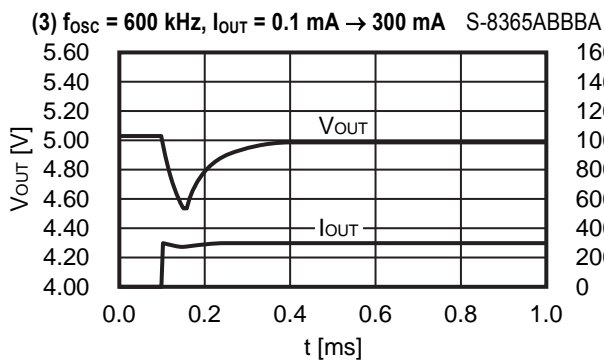
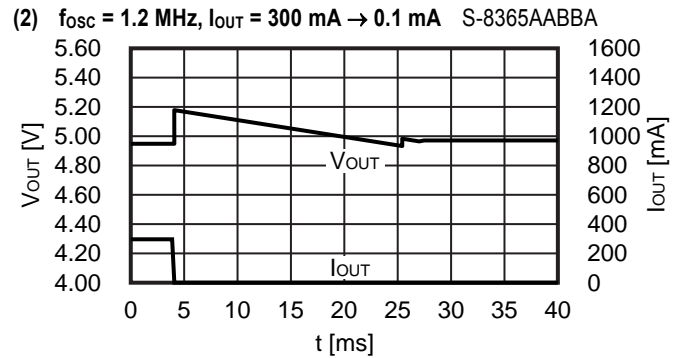
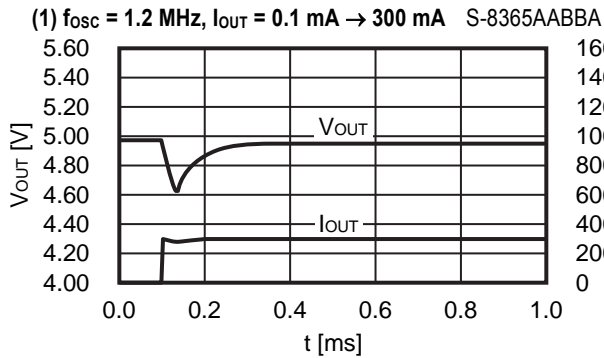

3.12 Load fluctuations ($V_{OUT} = 5.0\text{ V}$, $V_{IN} = 3.3\text{ V}$, $I_{OUT} = 0.1\text{ mA} \rightarrow 300\text{ mA} \rightarrow 0.1\text{ mA}$, PWM / PFM switching control, $T_a = 25^\circ\text{C}$)

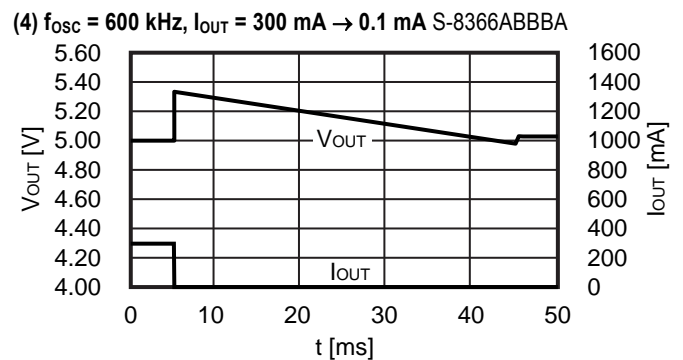
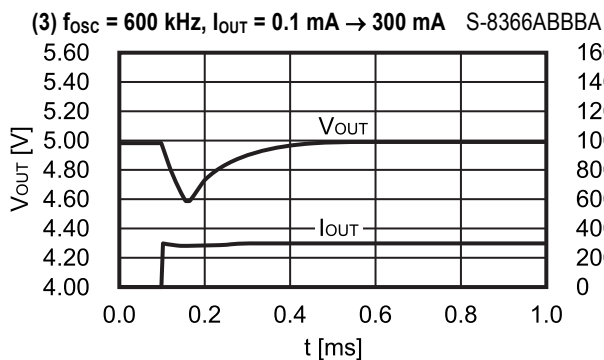
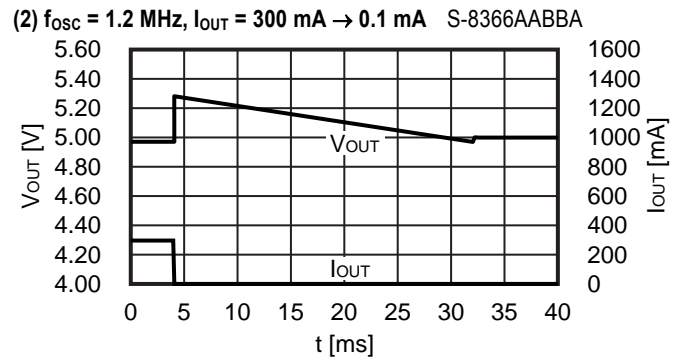
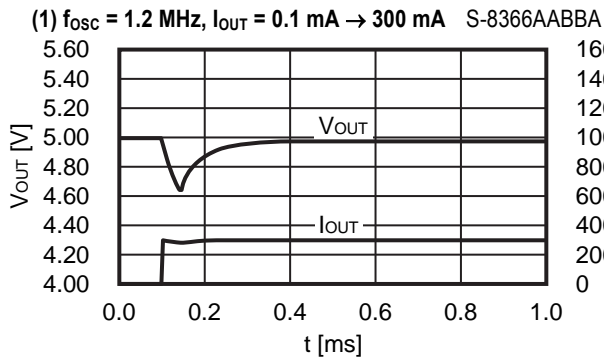

■ Reference Data

Reference data is provided to determine specific external components. Therefore, the following data shows the characteristics of the recommended external components selected for various applications.

1. External parts

Table 20 Efficiency vs. Output Current Characteristics and Output Voltage vs. Output Current Characteristics for External Parts (1 / 2)

Condition	Product Name	Oscillation Frequency	Control System	Output Voltage	L	M1	SD
1	S-8365AABBA	1.2 MHz	PWM	2.5 V	NR6028T-2R2M	MCH3406	RB050LA-30
2	S-8365ABBBA	600 kHz	PWM	2.5 V	LTF5022T-3R3M	MCH3406	RB050LA-30
3	S-8366AABBA	1.2 MHz	PWM / PFM	2.5 V	NR6028T-2R2M	MCH3406	RB050LA-30
4	S-8366ABBBA	600 kHz	PWM / PFM	2.5 V	LTF5022T-3R3M	MCH3406	RB050LA-30
5	S-8365AABBA	1.2 MHz	PWM	3.3 V	NR6028T-2R2M	MCH3406	RB050LA-30
6	S-8365ABBBA	600 kHz	PWM	3.3 V	LTF5022T-3R3M	MCH3406	RB050LA-30
7	S-8366AABBA	1.2 MHz	PWM / PFM	3.3 V	NR6028T-2R2M	MCH3406	RB050LA-30
8	S-8366ABBBA	600 kHz	PWM / PFM	3.3 V	LTF5022T-3R3M	MCH3406	RB050LA-30
9	S-8365AABBA	1.2 MHz	PWM	5.0 V	NR6028T-2R2M	MCH3406	RB050LA-30
10	S-8365ABBBA	600 kHz	PWM	5.0 V	LTF5022T-3R3M	MCH3406	RB050LA-30
11	S-8366AABBA	1.2 MHz	PWM / PFM	5.0 V	NR6028T-2R2M	MCH3406	RB050LA-30
12	S-8366ABBBA	600 kHz	PWM / PFM	5.0 V	LTF5022T-3R3M	MCH3406	RB050LA-30

Table 20 Efficiency vs. Output Current Characteristics and Output Voltage vs. Output Current Characteristics for External Parts (2 / 2)

Condition	C _{IN}	C _{OUT}	R _{FB1}	R _{FB2}	C _{FB}	C _{DD}
1	C2012X5R1A106KT	GRM31CR71A106KA × 2	47 kΩ	15 kΩ	68 pF	0.1 μF
2	C2012X5R1A106KT	GRM31CR71A106KA × 2	47 kΩ	15 kΩ	82 pF	0.1 μF
3	C2012X5R1A106KT	GRM31CR71A106KA × 2	47 kΩ	15 kΩ	68 pF	0.1 μF
4	C2012X5R1A106KT	GRM31CR71A106KA × 2	47 kΩ	15 kΩ	82 pF	0.1 μF
5	C2012X5R1A106KT	GRM31CR71A106KA × 2	68 kΩ	15 kΩ	68 pF	0.1 μF
6	C2012X5R1A106KT	GRM31CR71A106KA × 2	68 kΩ	15 kΩ	82 pF	0.1 μF
7	C2012X5R1A106KT	GRM31CR71A106KA × 2	68 kΩ	15 kΩ	68 pF	0.1 μF
8	C2012X5R1A106KT	GRM31CR71A106KA × 2	68 kΩ	15 kΩ	82 pF	0.1 μF
9	C2012X5R1A106KT	GRM31CR71A106KA × 2	110 kΩ	15 kΩ	56 pF	0.1 μF
10	C2012X5R1A106KT	GRM31CR71A106KA × 2	110 kΩ	15 kΩ	68 pF	0.1 μF
11	C2012X5R1A106KT	GRM31CR71A106KA × 2	110 kΩ	15 kΩ	56 pF	0.1 μF
12	C2012X5R1A106KT	GRM31CR71A106KA × 2	110 kΩ	15 kΩ	68 pF	0.1 μF

The properties of the external parts are shown below.

Table 21 Characteristics of External Parts

Part	Part Name	Manufacturer	Characteristics
Inductor	NR6028T-2R2M	Taiyo Yuden Co., Ltd.	2.2 μ H, DCR ^{*1} = 0.020 Ω , I _{MAX} ^{*2} = 4.2 A, L × W × H = 6.0 × 6.0 × 2.8 mm
	LTF5022T-3R3M	TDK Corporation	3.3 μ H, DCR ^{*1} = 0.060 Ω , I _{MAX} ^{*2} = 2.7 A, L × W × H = 5.0 × 5.2 × 2.2 mm
Diode	RB050LA-30	Rohm Co., Ltd.	V _F ^{*3} = 0.45 V, I _F ^{*4} = 3.0 A, V _R ^{*5} = 30 V L × W × H = 4.7 × 2.6 × 1.05 mm
Transistor	MCH3406	Sanyo Semiconductor Co., Ltd.	V _{DSS} ^{*6} = 20 V, V _{GSS} ^{*7} = ±10 V, I _D ^{*8} = 3.0 A, Q _G ^{*9} = 8.8 nC typ., R _{DS(ON)} ^{*10} = 0.082 Ω max. (V _{GS} ^{*11} = 2.5 V) L × W × H = 2.1 × 2.0 × 0.85 mm
Capacitor	C2012X5R1A106KT	TDK Corporation	10 μ F, E _{DC} ^{*12} = 10 V, X5R, L × W × H = 2.0 × 1.25 × 1.45 mm
	C1005X7R1C104KT		0.1 μ F, E _{DC} ^{*12} = 16 V, X7R, L × W × H = 1.0 × 0.5 × 0.55 mm
	GRM31CR71A106KA	Murata Manufacturing, Co., Ltd.	10 μ F, E _{DC} ^{*12} = 10 V, X7R, L × W × H = 3.2 × 1.6 × 1.6 mm

- * 1. DCR : DC resistance
- * 2. I_{MAX} : Maximum allowable current
- * 3. V_F : Forward voltage
- * 4. I_F : Forward current
- * 5. V_R : Reverse voltage
- * 6. V_{DSS} : Drain-source voltage (during short-circuiting between the gate and source)
- * 7. V_{GSS} : Gate-source voltage (during short-circuiting between the drain and source)
- * 8. I_D : Drain current
- * 9. Q_G : Gate charge
- * 10. R_{DS(ON)} : On-resistance between the drain and source
- * 11. V_{GS} : Gate-source voltage
- * 12. E_{DC} : Rated voltage

Caution The values shown in the characteristics column of Table 21 above are based on the materials provided by each manufacture. However, consider the characteristics of the original materials when using the above products.

2. Output Current (I_{OUT}) vs. Efficiency (η) Characteristics, Output Current (I_{OUT}) vs. Output Voltage (V_{OUT}) Characteristics

Following shows the actual output current (I_{OUT}) vs. efficiency (η) and output current (I_{OUT}) vs. output voltage (V_{OUT}) characteristics for conditions 1 to 12 in **Table 20**.

Condition 1 S-8365AABBA ($V_{OUT(S)} = 2.5$ V)

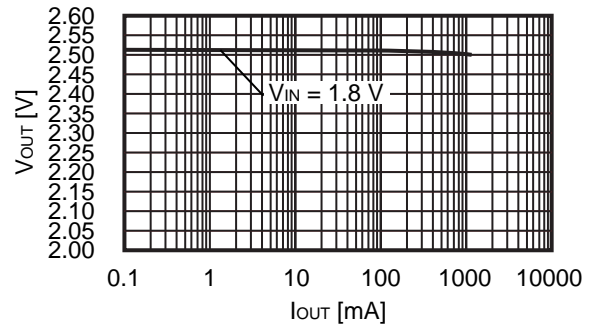
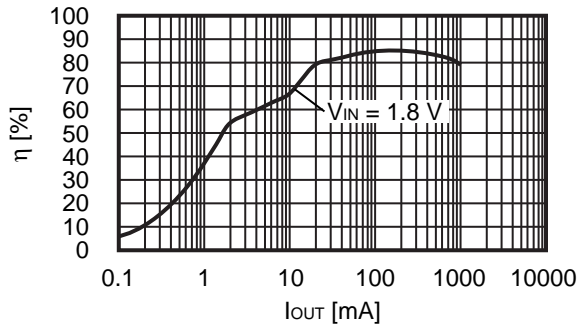

Condition 2 S-8365ABBBA ($V_{OUT(S)} = 2.5$ V)

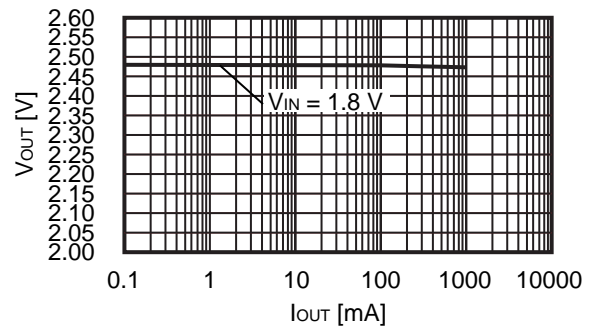
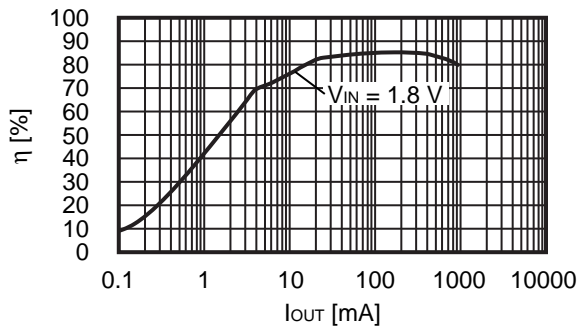

Condition 3 S-8366AABBA ($V_{OUT(S)} = 2.5$ V)

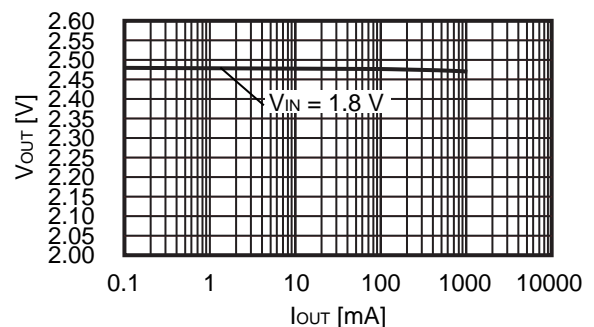
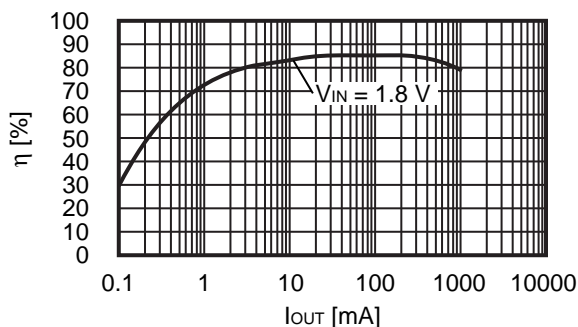

Condition 4 S-8366ABBBA ($V_{OUT(S)} = 2.5$ V)

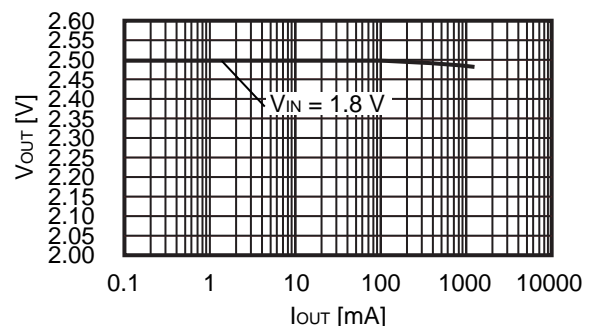
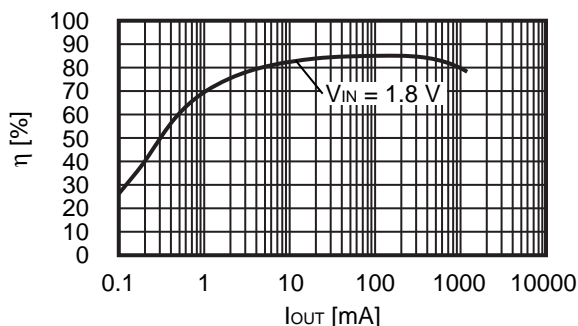

Condition 5 S-8365AABBA ($V_{OUT(S)} = 3.3\text{ V}$)

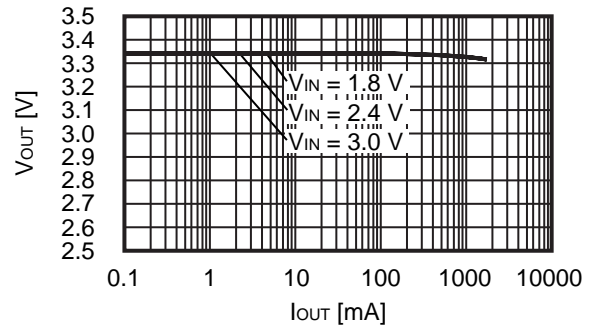
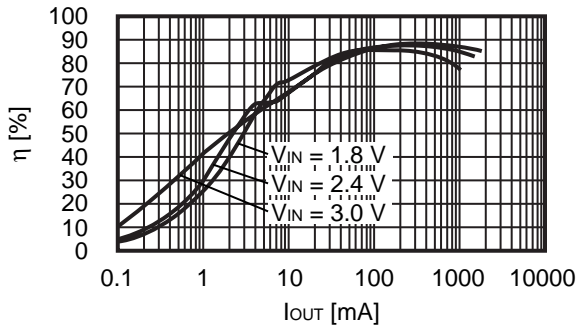

Condition 6 S-8365ABBBA ($V_{OUT(S)} = 3.3\text{ V}$)

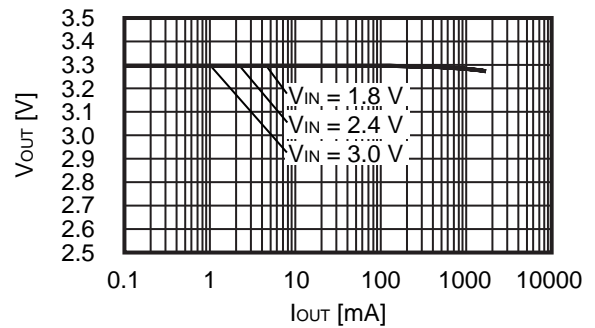
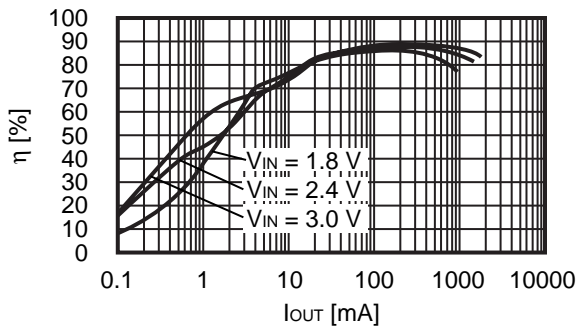

Condition 7 S-8366AABBA ($V_{OUT(S)} = 3.3\text{ V}$)

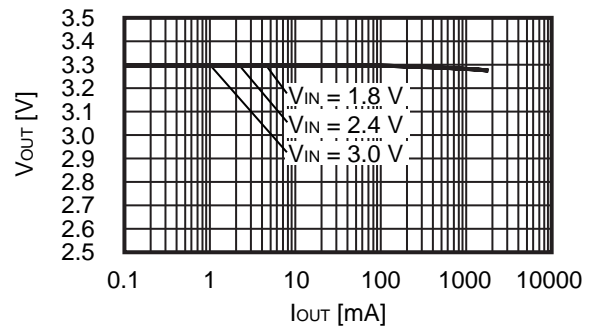
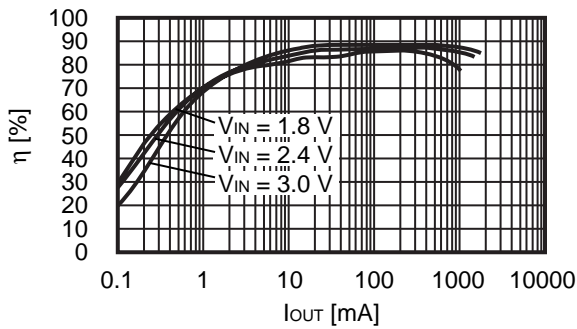

Condition 8 S-8366ABBBA ($V_{OUT(S)} = 3.3\text{ V}$)

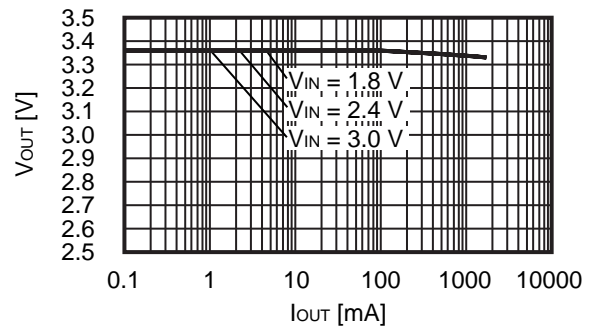
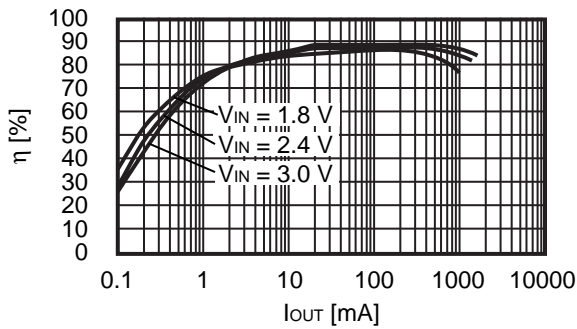

Condition 9 S-8365AABBA ($V_{OUT(S)} = 5.0\text{ V}$)

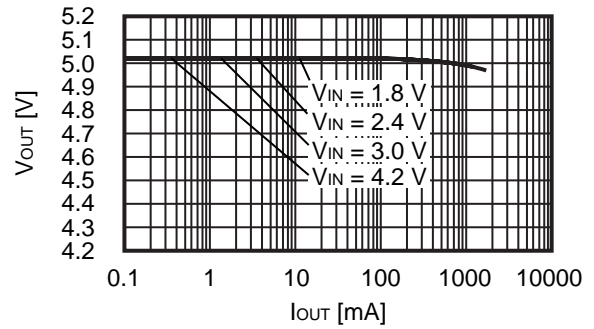
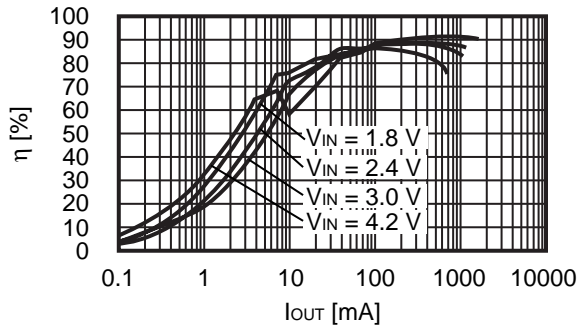

Condition 10 S-8365ABBBA ($V_{OUT(S)} = 5.0\text{ V}$)

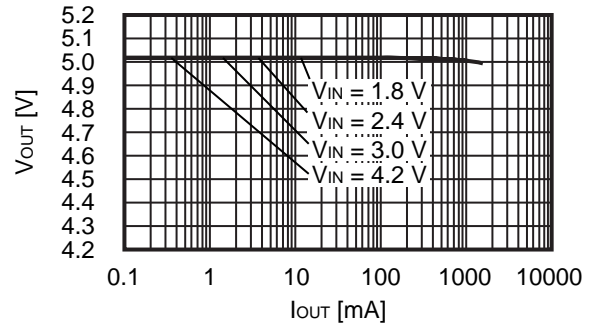
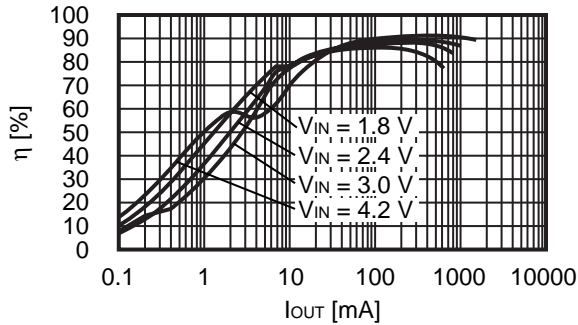

Condition 11 S-8366AABBA ($V_{OUT(S)} = 5.0\text{ V}$)

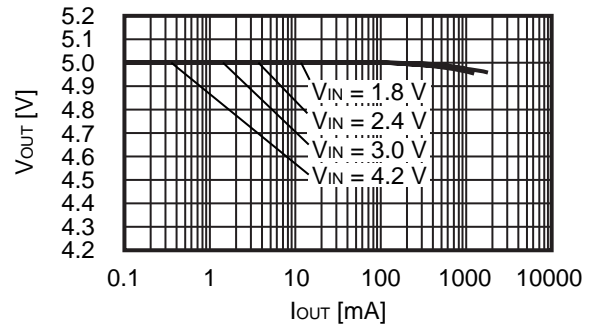
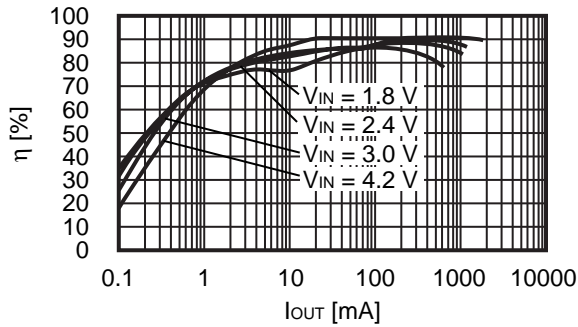

Condition 12 S-8366ABBBA ($V_{OUT(S)} = 5.0\text{ V}$)

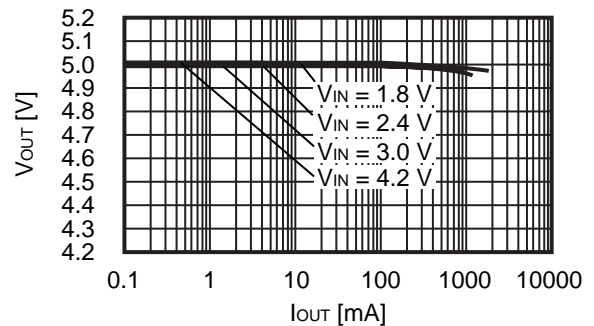
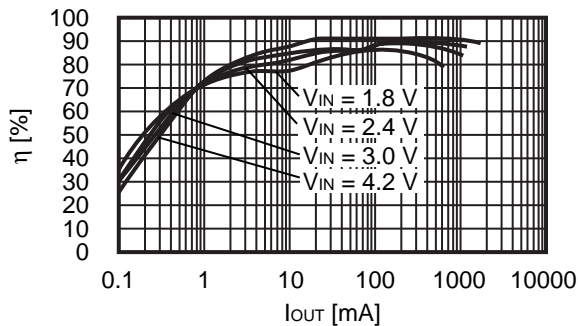

3. Output Current (I_{OUT}) vs. Ripple Voltage (V_r) Characteristics

Following shows the actual output current (I_{OUT}) vs. ripple voltage (V_r) characteristics for conditions of 1 to 12 in Table 20.

Condition 1 S-8365AABBA ($V_{OUT(S)} = 2.5\text{ V}$)

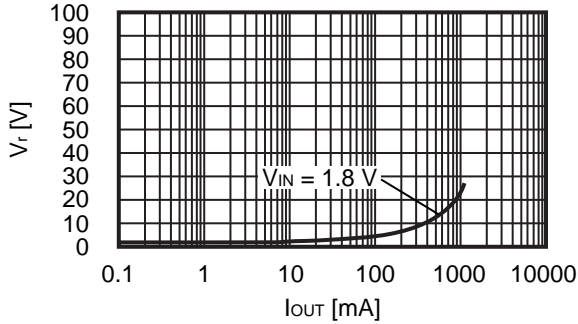

Condition 2 S-8365ABBBA ($V_{OUT(S)} = 2.5\text{ V}$)

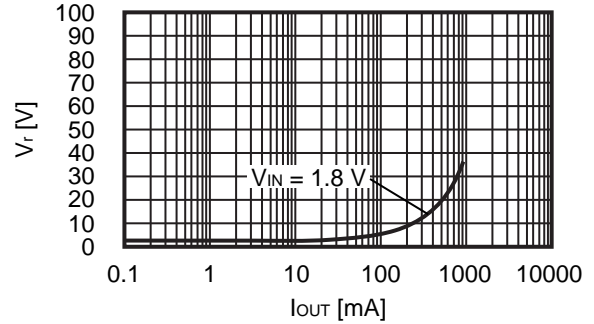

Condition 3 S-8366AABBA ($V_{OUT(S)} = 2.5\text{ V}$)

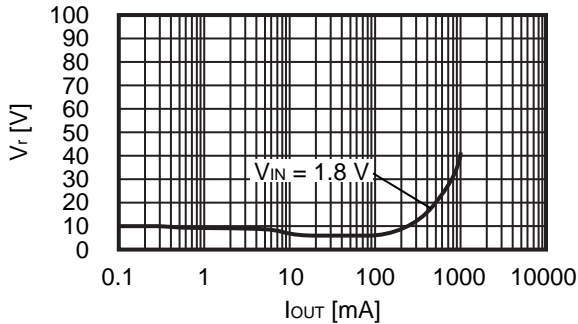

Condition 4 S-8366ABBBA ($V_{OUT(S)} = 2.5\text{ V}$)

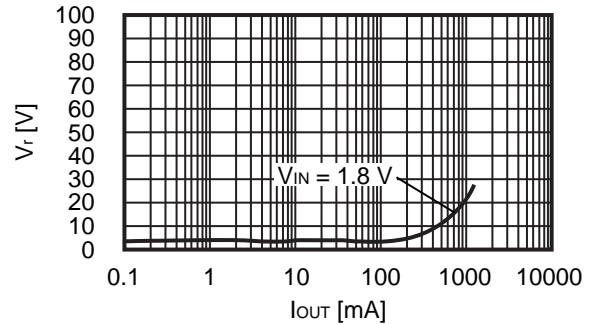

Condition 5 S-8365AABBA ($V_{OUT(S)} = 3.3\text{ V}$)

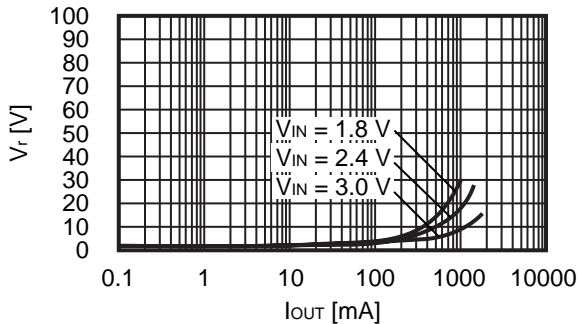

Condition 6 S-8365ABBBA ($V_{OUT(S)} = 3.3\text{ V}$)

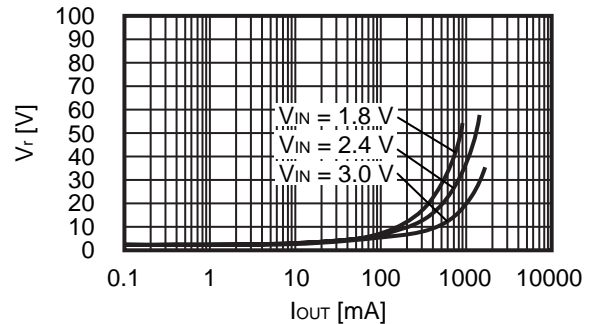

Condition 7 S-8366AABBA ($V_{OUT(S)} = 3.3\text{ V}$)

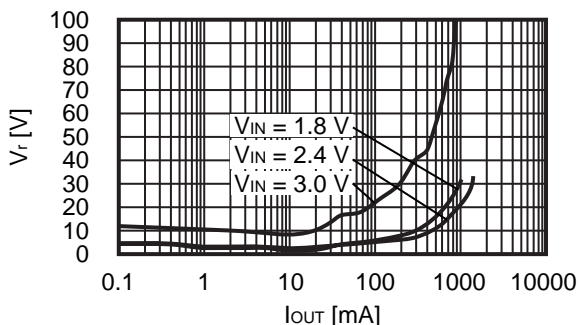

Condition 8 S-8366ABBBA ($V_{OUT(S)} = 3.3\text{ V}$)

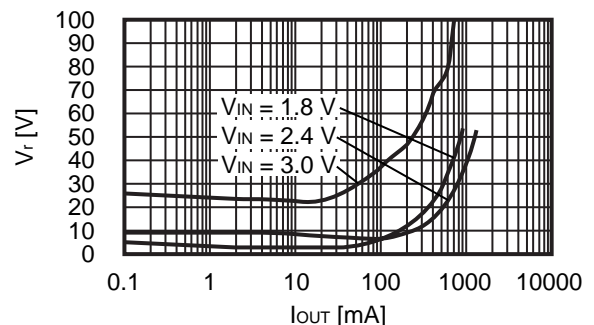

Condition 9 S-8365AABBA ($V_{OUT(S)} = 5.0\text{ V}$)

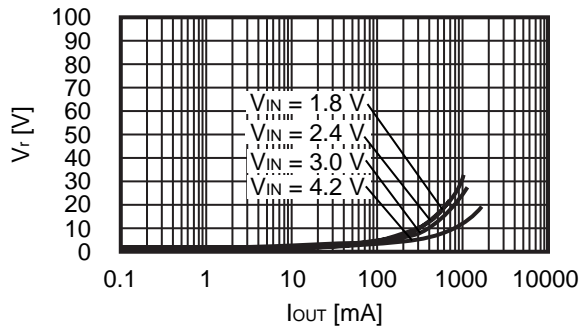

Condition 10 S-8365ABBBA ($V_{OUT(S)} = 5.0\text{ V}$)

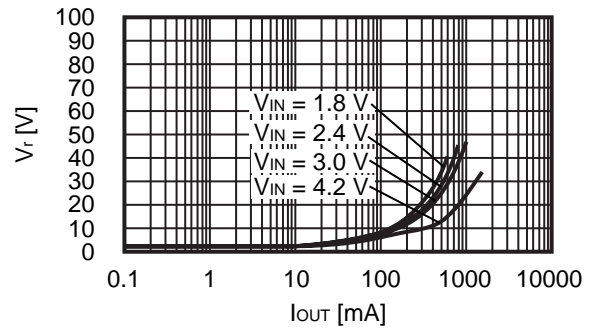

Condition 11 S-8366AABBA ($V_{OUT(S)} = 5.0\text{ V}$)

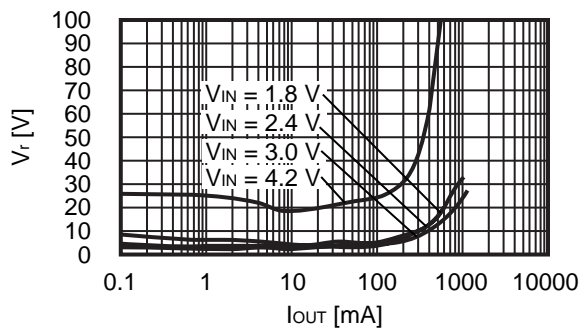

Condition 12 S-8366ABBBA ($V_{OUT(S)} = 5.0\text{ V}$)

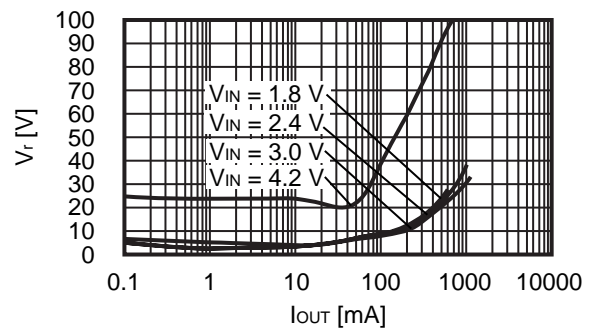

■ **Marking Specification**

(1) **SNT-6A**

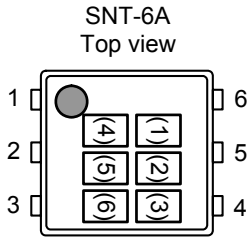

(1) to (3) : Product code (Refer to **Product name vs. Product code**)
 (4) to (6) : Lot number

Product name vs. Product code

(a) **S-8365 Series**

Product name	Product code		
	(1)	(2)	(3)
S-8365AAAAA-I6T1x2	U	Q	A
S-8365AAABA-I6T1x2	U	Q	C
S-8365AABBA-I6T1x2	U	Q	G
S-8365ABAAA-I6T1x2	U	Q	I
S-8365ABABA-I6T1x2	U	Q	K
S-8365ABBBA-I6T1x2	U	Q	O

(b) **S-8366 Series**

Product name	Product code		
	(1)	(2)	(3)
S-8366AAAAA-I6T1x2	U	Q	R
S-8366AAABA-I6T1x2	U	Q	T
S-8366AABBA-I6T1x2	U	Q	X
S-8366ABAAA-I6T1x2	U	Q	Z
S-8366ABABA-I6T1x2	U	Q	3
S-8366ABBBA-I6T1x2	U	Q	7

(2) **SOT-23-5**

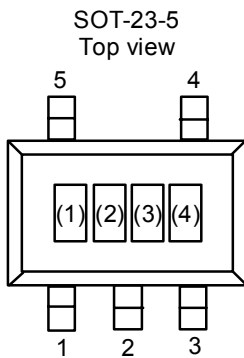

(1) to (3) : Product code (Refer to **Product name vs. Product code**)
 (4) : Lot number

Product name vs. Product code

(a) **S-8365 Series**

Product name	Product code		
	(1)	(2)	(3)
S-8365AAAAA-M5T1y2	U	Q	A
S-8365AAABA-M5T1y2	U	Q	C
S-8365ABAAA-M5T1y2	U	Q	I
S-8365ABABA-M5T1y2	U	Q	K

(b) **S-8366 Series**

Product name	Product code		
	(1)	(2)	(3)
S-8366AAAAA-M5T1y2	U	Q	R
S-8366AAABA-M5T1y2	U	Q	T
S-8366ABAAA-M5T1y2	U	Q	Z
S-8366ABABA-M5T1y2	U	Q	3

Remark 1. x: G or U
 y: S or U

2. Please select products of environmental code = U for Sn 100%, halogen-free products.

(3) SOT-23-6

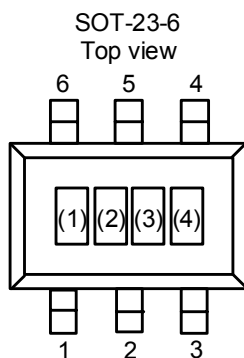

(1) to (3) : Product code (Refer to **Product name vs. Product code**)
 (4) : Lot number

Product name vs. Product code

(a) S-8365 Series

Product name	Product code		
	(1)	(2)	(3)
S-8365AABBA-M6T1y2	U	Q	G
S-8365ABBBA-M6T1y2	U	Q	O

(b) S-8366 Series

Product name	Product code		
	(1)	(2)	(3)
S-8366AABBA-M6T1y2	U	Q	X
S-8366ABBBA-M6T1y2	U	Q	7

Remark 1. y: S or U

2. Please select products of environmental code = U for Sn 100%, halogen-free products.

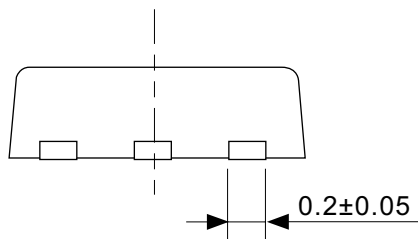
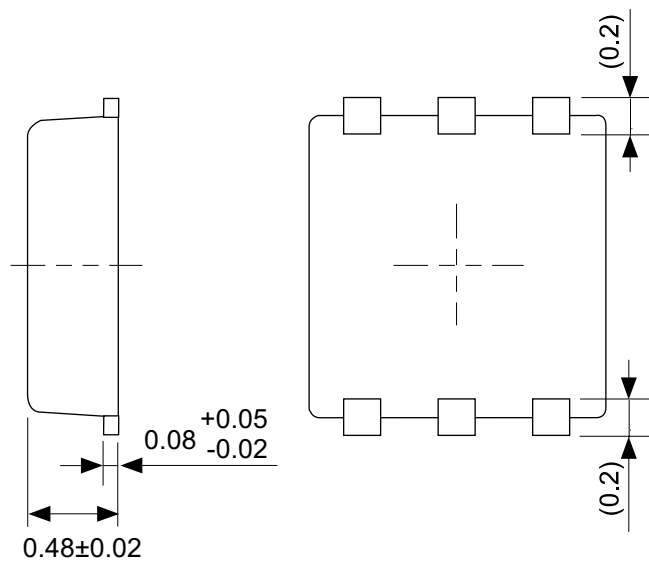
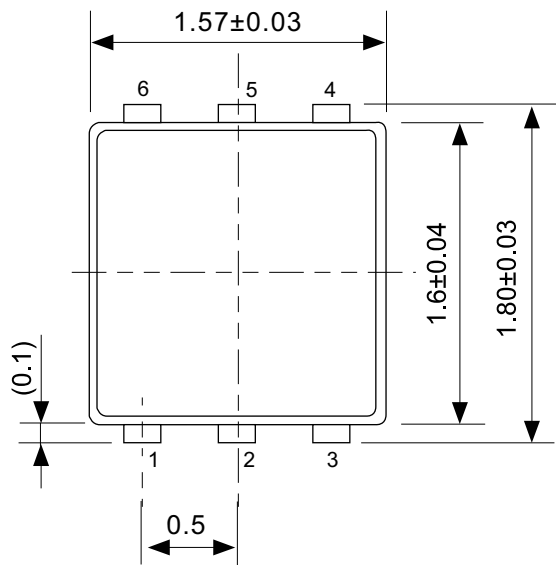

No. PG006-A-P-SD-2.0

TITLE	SNT-6A-A-PKG Dimensions
No.	PG006-A-P-SD-2.0
SCALE	
UNIT	mm
Seiko Instruments Inc.	

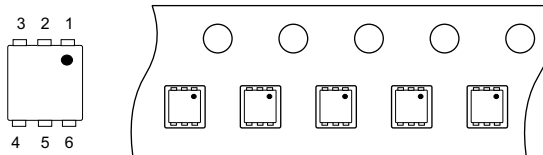
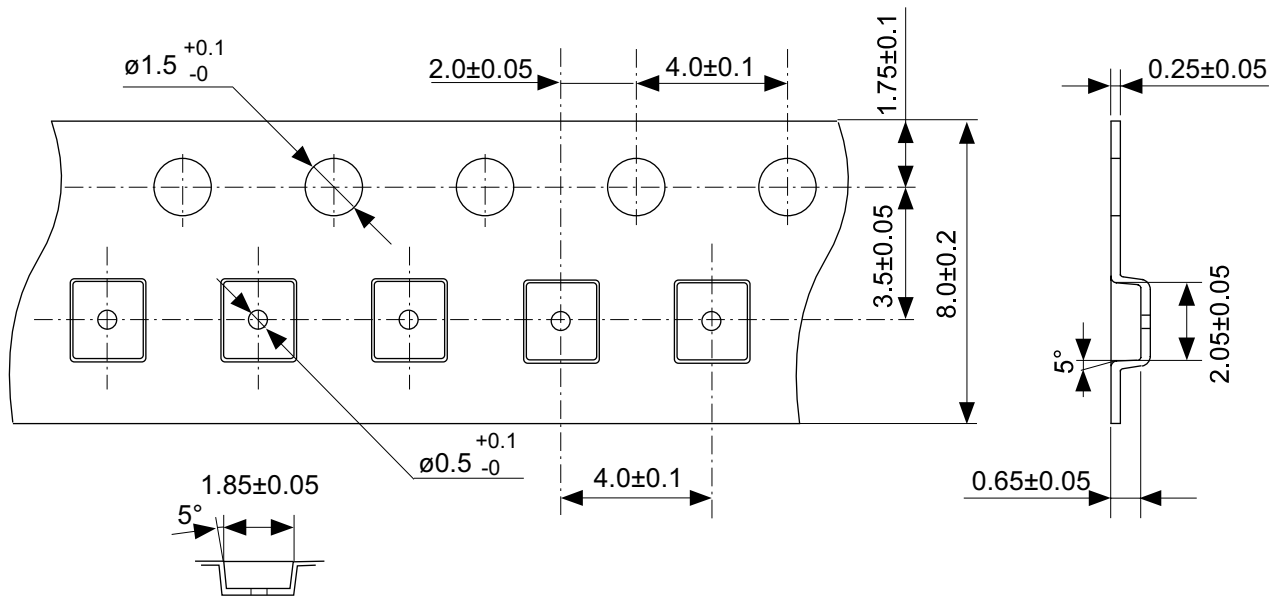

→
Feed direction

No. PG006-A-C-SD-1.0

TITLE	SNT-6A-A-Carrier Tape
No.	PG006-A-C-SD-1.0
SCALE	
UNIT	mm
Seiko Instruments Inc.	

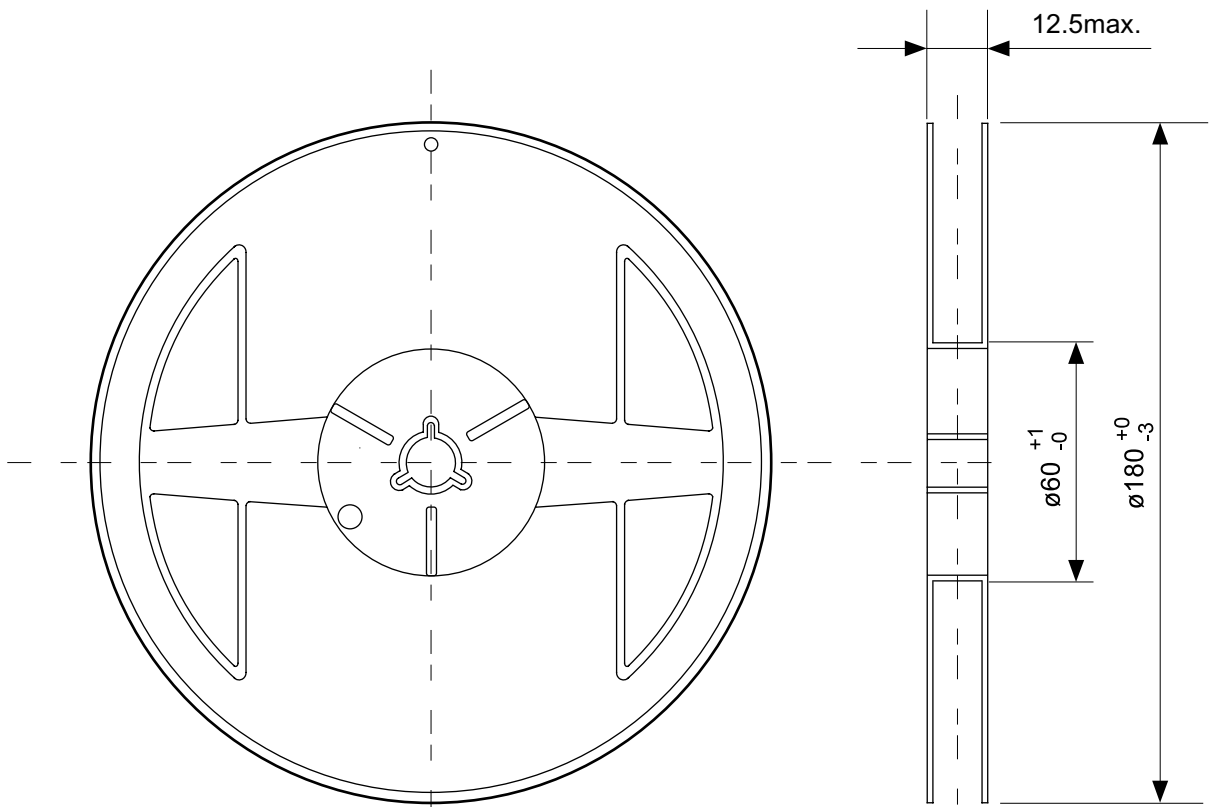

Enlarged drawing in the central part

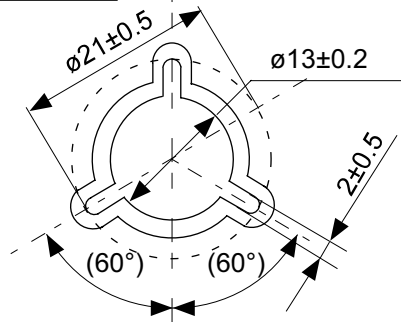

No. PG006-A-R-SD-1.0

TITLE	SNT-6A-A-Reel		
No.	PG006-A-R-SD-1.0		
SCALE		QTY.	5,000
UNIT	mm		
Seiko Instruments Inc.			

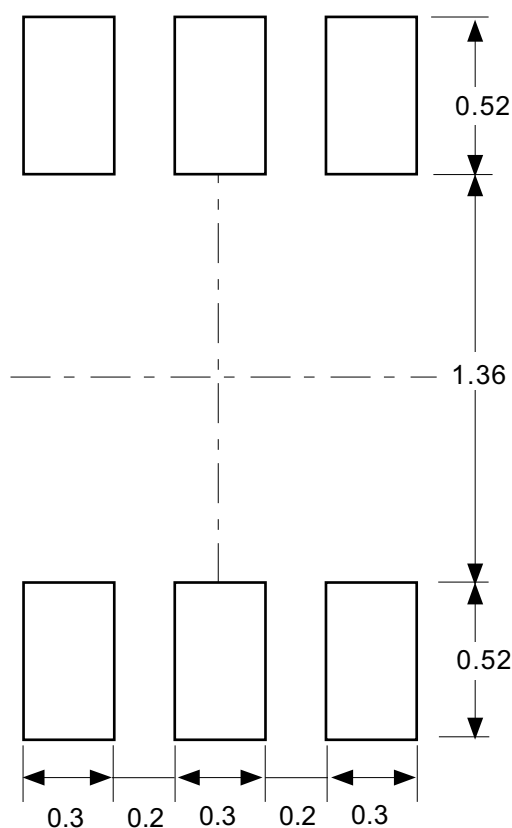

Caution Making the wire pattern under the package is possible. However, note that the package may be upraised due to the thickness made by the silk screen printing and of a solder resist on the pattern because this package does not have the standoff.

注意 パッケージ下への配線パターン形成は可能ですが、本パッケージはスタンドオフが無いので、パターン上のレジスト厚み、シルク印刷の厚みによってパッケージが持ち上がる場合がありますのでご配慮ください。

No. PG006-A-L-SD-3.0

TITLE	SNT-6A-A-Land Recommendation
No.	PG006-A-L-SD-3.0
SCALE	
UNIT	mm
Seiko Instruments Inc.	

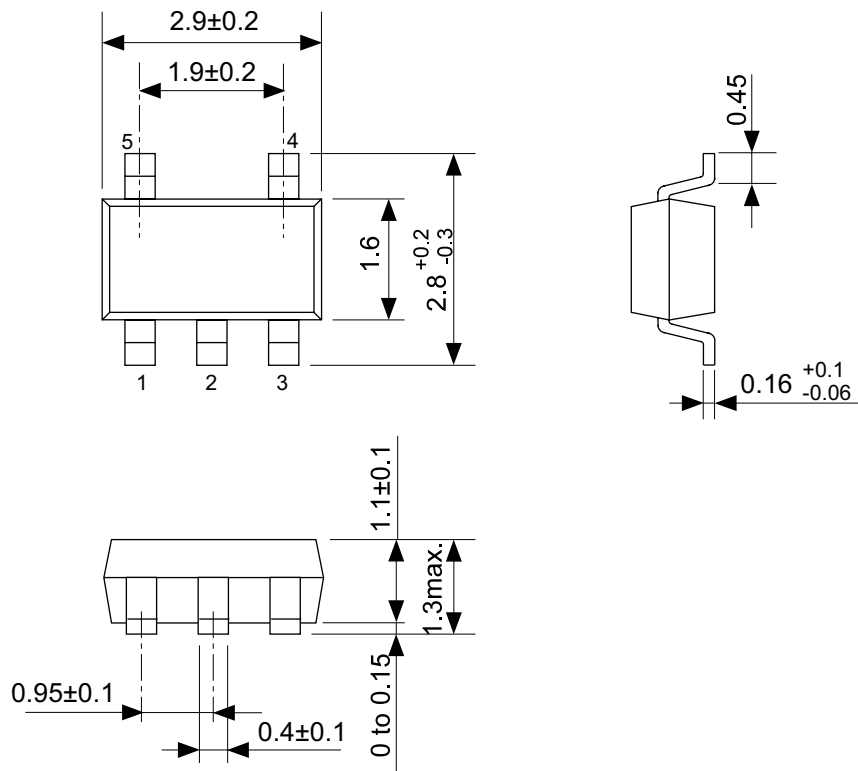

No. MP005-A-P-SD-1.2

TITLE	SOT235-A-PKG Dimensions
No.	MP005-A-P-SD-1.2
SCALE	
UNIT	mm
Seiko Instruments Inc.	

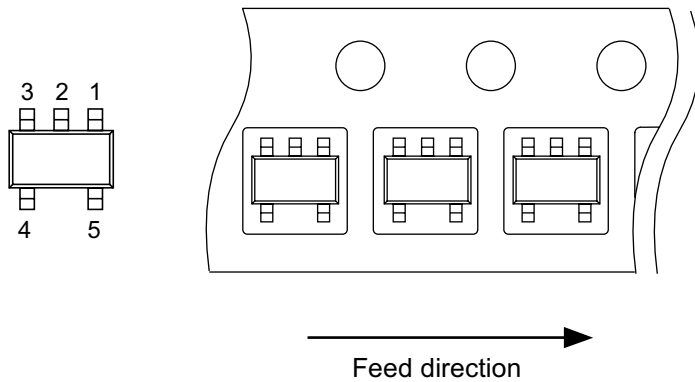
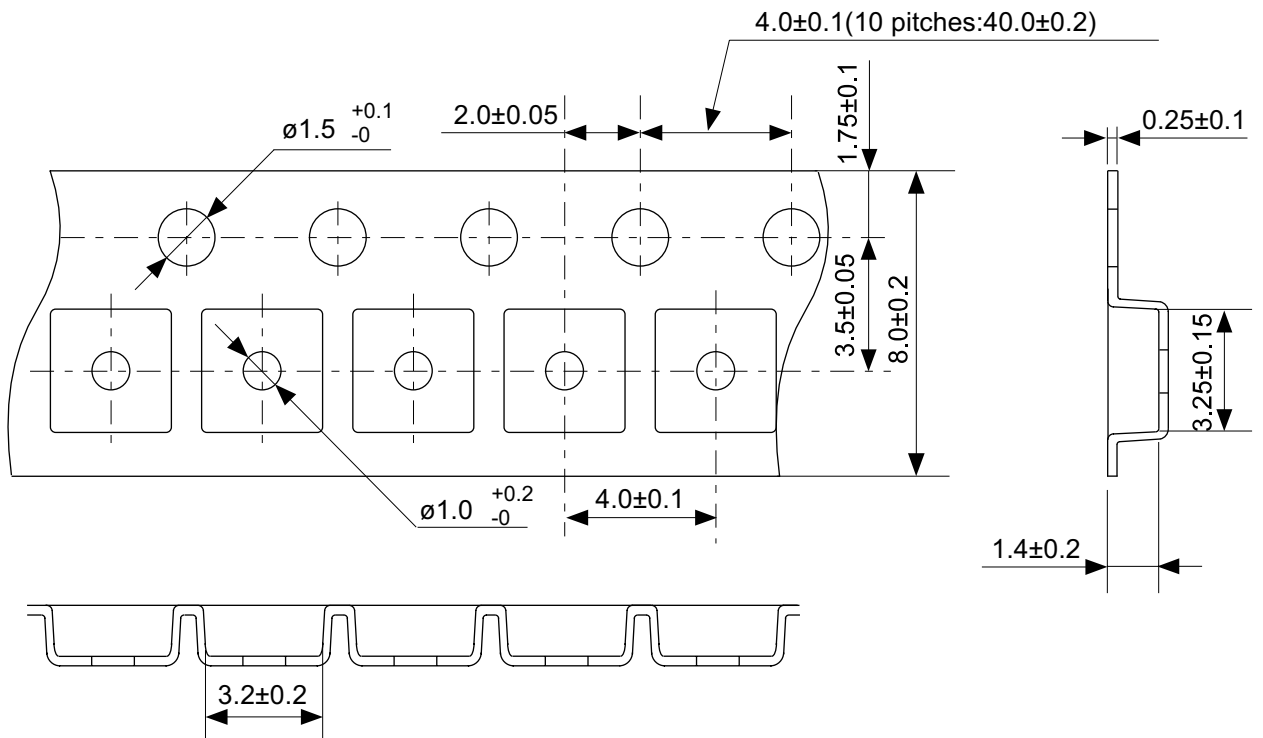

No. MP005-A-C-SD-2.1

TITLE	SOT235-A-Carrier Tape
No.	MP005-A-C-SD-2.1
SCALE	
UNIT	mm
Seiko Instruments Inc.	

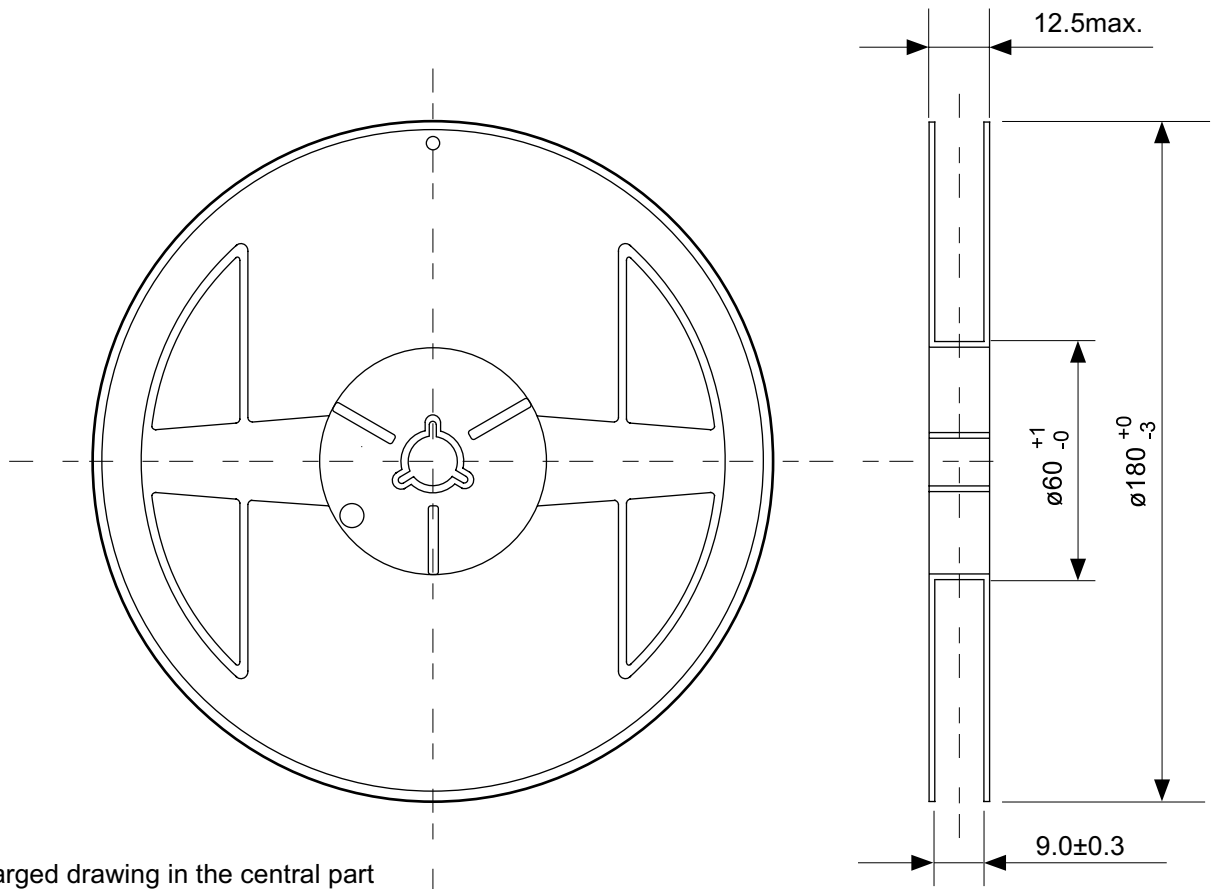

Enlarged drawing in the central part

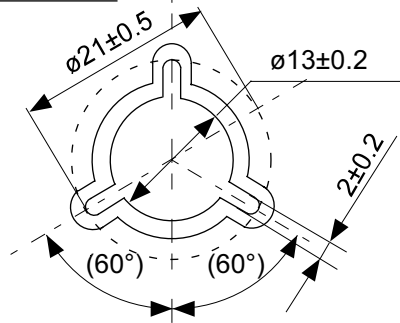

No. MP005-A-R-SD-1.1

TITLE	SOT235-A-Reel		
No.	MP005-A-R-SD-1.1		
SCALE		QTY.	3,000
UNIT	mm		
Seiko Instruments Inc.			

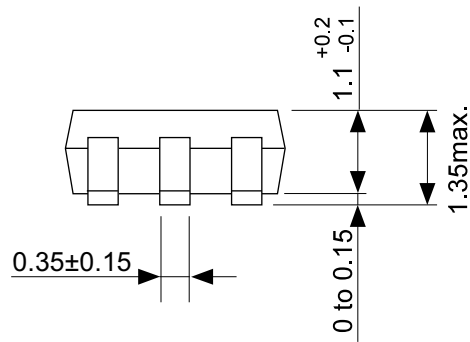
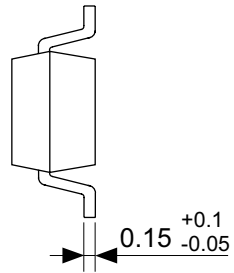
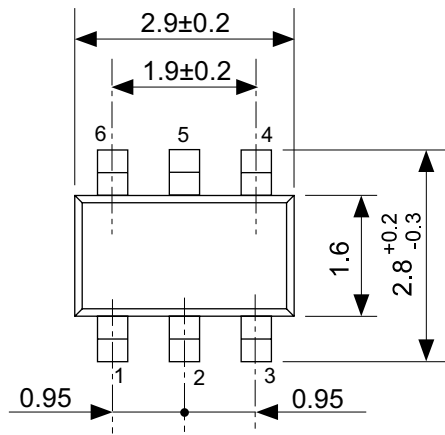

No. MP006-A-P-SD-1.1

TITLE	SOT236-A-PKG Dimensions
No.	MP006-A-P-SD-1.1
SCALE	
UNIT	mm
Seiko Instruments Inc.	

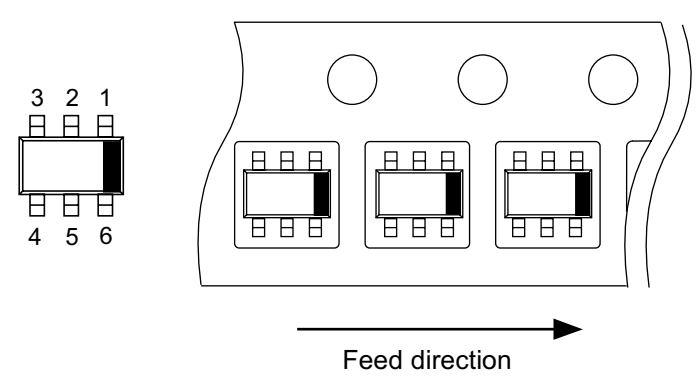
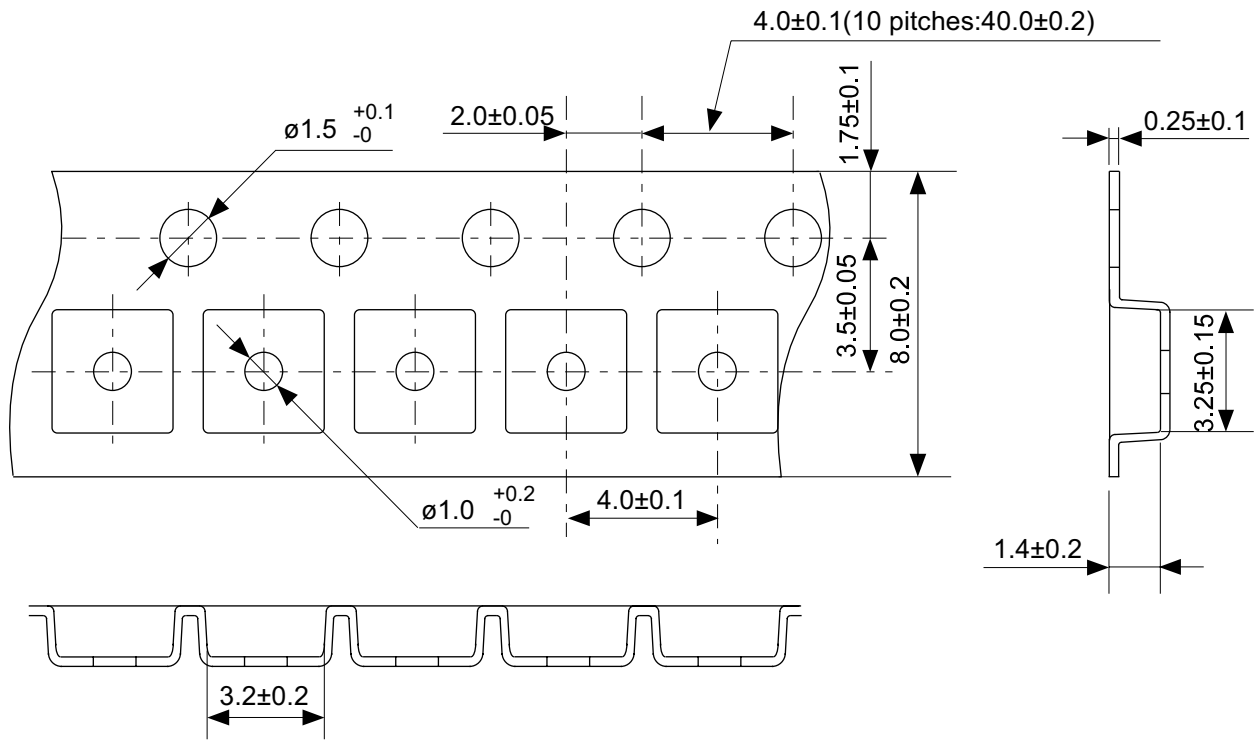

No. MP006-A-C-SD-3.1

TITLE	SOT236-A-Carrier Tape
No.	MP006-A-C-SD-3.1
SCALE	
UNIT	mm
Seiko Instruments Inc.	

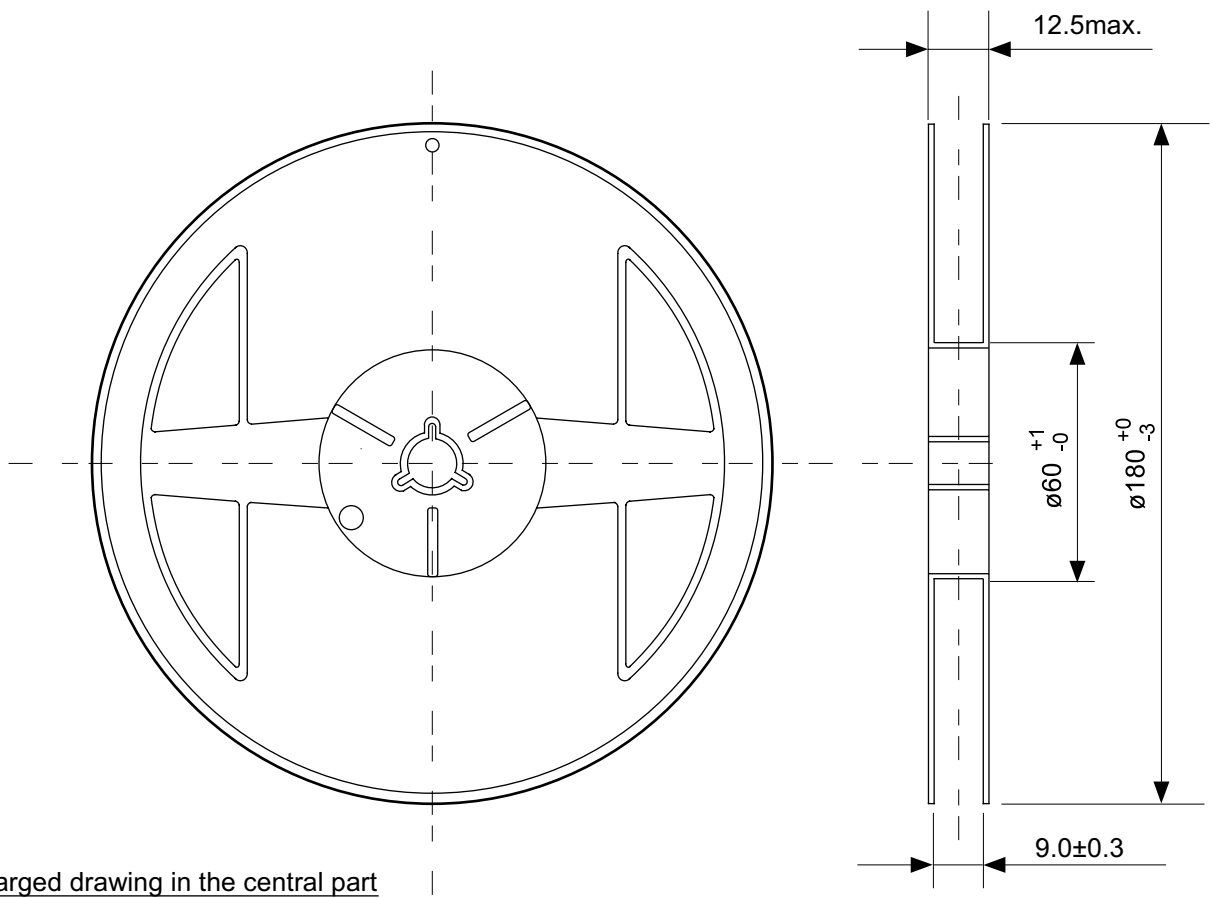

Enlarged drawing in the central part

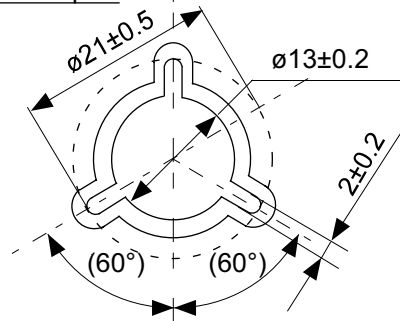

No. MP006-A-R-SD-2.1

TITLE	SOT236-A-Reel		
No.	MP006-A-R-SD-2.1		
SCALE		QTY	3,000
UNIT	mm		
Seiko Instruments Inc.			



Seiko Instruments Inc.
www.sii-ic.com

- The information described herein is subject to change without notice.
- Seiko Instruments Inc. is not responsible for any problems caused by circuits or diagrams described herein whose related industrial properties, patents, or other rights belong to third parties. The application circuit examples explain typical applications of the products, and do not guarantee the success of any specific mass-production design.
- When the products described herein are regulated products subject to the Wassenaar Arrangement or other agreements, they may not be exported without authorization from the appropriate governmental authority.
- Use of the information described herein for other purposes and/or reproduction or copying without the express permission of Seiko Instruments Inc. is strictly prohibited.
- The products described herein cannot be used as part of any device or equipment affecting the human body, such as exercise equipment, medical equipment, security systems, gas equipment, or any apparatus installed in airplanes and other vehicles, without prior written permission of Seiko Instruments Inc.
- Although Seiko Instruments Inc. exerts the greatest possible effort to ensure high quality and reliability, the failure or malfunction of semiconductor products may occur. The user of these products should therefore give thorough consideration to safety design, including redundancy, fire-prevention measures, and malfunction prevention, to prevent any accidents, fires, or community damage that may ensue.